

# Spectroscopy Solutions

A Modular Approach

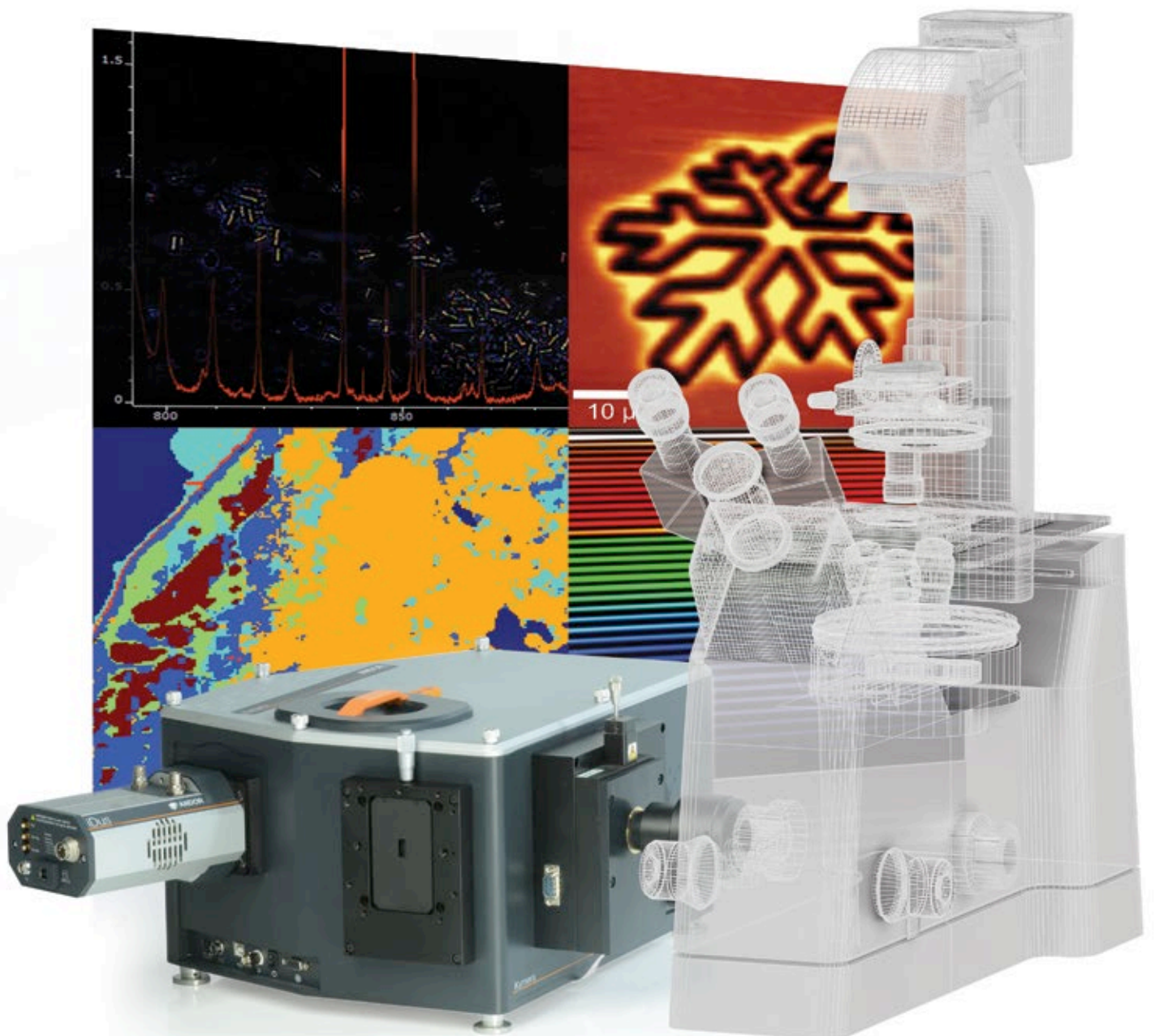





# Our Expertise

Our experience has enabled us to bring together the latest cutting-edge technology in the fields of sensors, electronics, optics, vacuum technology and software to deliver world-class, market-leading scientific spectroscopy detection systems. Andor's experience in manufacturing high-performance spectroscopy systems spans over 28 years, with thousands of detectors in the field and a proud history of remarkable advances in a wide variety of research areas, truly helping scientists all over the world to discover new ways of seeing.



## CCD Basics

A Charge Coupled Device, or CCD, is a 2D matrix of silicon diode photo-sensors referred to as "pixels". Incident photons with sufficient energy are absorbed in the silicon bulk and liberate an electron, which can be stored and detected as part of a readout sequence. Photons with wavelength  $>1.1 \mu\text{m}$  do not have enough energy to create a free electron and therefore set the upper detection limit of silicon CCDs.

The probability of detecting a photon at a particular wavelength is known as Quantum Efficiency (QE). QE will vary with depletion depth of the silicon, quality of the CCD structural layers and clocking electrodes "transparency".

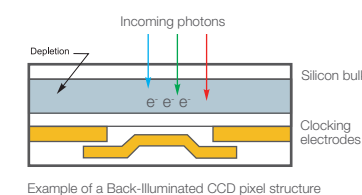

At the end of an exposure, the CCD pixel charges are transferred sequentially under a masked area known as the shift register. This serial register connects to an amplifier that digitizes the signal and allows a quantitative readout of the amount of electrons per pixel.

The principal types of high performance CCD-based digital cameras include:

- The Charge-Coupled-Device (CCD)
- The Electron-Multiplying CCD (EMCCD) with on-chip gain for sensitivity down to a single photon
- The Intensified CCD (ICCD) - Image Intensifier provides fast nanosecond optical shuttering and signal amplification

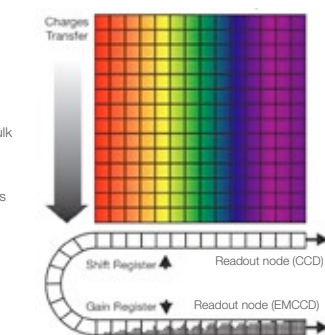

## Benefits of Ultravac™ technology for research-grade cooled detectors

Unless protected, cooled CCD, EMCCDs or InGaAs sensors will condense moisture, hydrocarbons and other gas contaminants. Exposed to such outgassed contaminants when cooled, the Quantum Efficiency of sensors will decline proportionally. Andor's Ultravac™ offers the following benefits:

- Maintenance-free operation in-laboratory or in-field over extended periods of time, unlike liquid nitrogen (LN<sub>2</sub>) cooled platforms that require hazardous and regular manual Dewar refills.
- Operating temperature of the chip can be reduced significantly. Better cooling with an enhanced thermoelectric (TE) Peltier design translates into substantially lower darkcurrent and fewer "hot" blemishes.
- No peak QE and sensor cooling performance degradation over many years operation. Andor Ultravac™ technology offers an MTBF (mean time between failure) of more than 100 years.

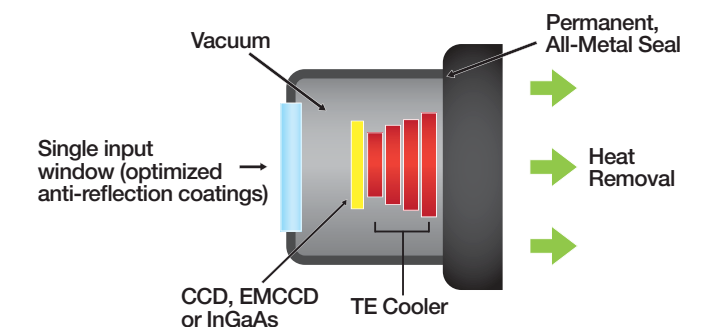

## Making sense of sensitivity: signal-to-noise ratio considerations

A camera Signal-to-Noise Ratio (commonly abbreviated to S/N or SNR) is the true comparison basis between detectors and detector technologies. It takes into account both the photon capture capability of the detector and the different noise sources along the detection path that can impact on the integrity of the useful signal. The sources of this noise are the following:

### Readout noise

Inherent sensor electron-to-voltage conversion and amplification noise

### Thermal noise

Originating from sensor, blackbody radiation (SWIR region) or image intensifier photocathode

### Photon noise / Shot noise

Statistical incoming photon variation

### Spurious Charge / Clocking Induced Charge (CIC)

Result of impact ionization during charge transfer

### CCD

Sensitivity is shot noise and readout noise limited - typically used at slow digitization speeds

### EMCCD

Sensitivity is shot noise and CIC limited - typically used for photon-starved and ultrafast spectroscopy

### ICCD

Sensitivity is shot noise and photocathode thermal noise (EBI) limited - typically used for ns time-resolution

$$Noise_{total} = \sqrt{N_{readout}^2 + F^2 \cdot G^2 \cdot (N_{darknoise}^2 + N_{photon}^2 + N_{CIC}^2)}$$

F = amplification noise factor  
G = amplification gain

# Spectroscopy Cameras

Andor has been taking pride in helping researchers around the world achieve breakthrough discoveries for the last 28 years. By keeping at the forefront of detector technology, Andor is able to offer a range of market leading high-performance, ultra sensitive spectroscopy detectors. Our CCDs, ICCDs, EMCCDs, sCMOS and InGaAs arrays can operate from the VUV to Near-Infrared spectral regions with a unique combination of high sensitivity (down to single photon in the case of EMCCD technology) and ultrafast acquisition speeds.



## CCD

Workhorse Broadband Platform  
Newton CCD, iDus CCD

A two dimensional silicon-based semiconductor matrix of photo-sensors, with sensitivity ranging from soft X-ray to NIR (1.1  $\mu\text{m}$ ). Spectroscopy CCDs are traditionally a rectangular format with a maximum width of 30 mm and a height up to 13 mm, i.e. matching the focal plane size of the majority of high-end spectrographs.

## Electron Multiplying CCD

High Sensitivity and Speed  
Newton<sup>EM</sup>, iXon Ultra EMCCD

Identical architecture to standard CCD sensors, with the addition of an on-chip amplification channel prior to the digitization node, designed to overcome the readout noise limitation of slow-scan CCDs. This technology opens the door to ultra-sensitive and ultra-fast spectroscopy.

## Intensified Detectors

Nanosecond Time Resolution  
iStar ICCD

Combination of a CCD or sCMOS matrix with a fiber coupled Image Intensifier, which provides optical shuttering capabilities and time-resolution down to the nanosecond regime while also offering a signal amplification up to x1,000.

## InGaAs

Short Wave IR Spectroscopy  
InGaAs CCD

Indium Gallium Arsenide (InGaAs) is a photo-sensitive material used for detection up to 2.2  $\mu\text{m}$ . The typical sensor architecture for spectroscopy applications is a single row array of up to 25.6 mm.

## sCMOS

High speed and dynamic range  
Zyla sCMOS

Scientific CMOS (sCMOS) provides a unique combination of high resolution pixels, high spectral rates up to 26,000 sps, low noise and high dynamic range simultaneously. This technology is perfectly suited for fast transient phenomena or fast extended multi-track analysis.

## Sensor Type

Sensor Type	Description
LDC-DD	Back-illuminated, deep-depletion low dark current CCD with fringe suppression
BVF	Back-illuminated CCD, VIS optimized with fringe suppression
BEX2-DD	Back-illuminated, deep-depletion CCD, broadband dual-AR coating with fringe suppression
BR-DD	Back-illuminated, deep-depletion CCD with fringe suppression
BU	Back-illuminated CCD, UV-Enhanced, 350 nm optimized
BU2	Back-illuminated CCD, UV-Enhanced, 250 nm optimized
BV	Back-illuminated CCD, VIS optimized
FI	Front-illuminated CCD
OE	Open-Electrode CCD
UV	Front-illuminated CCD with UV coating
UVB	Back-illuminated CCD with UV coating

## Applications

Applications	Newton CCD	Newton <sup>EM</sup> EMCCD	iXon Ultra EMCCD	iDus CCD	InGaAs CCD	iStar ICCD	Zyla sCMOS
Absorption - Transmission - Reflection	UV-NIR <sup>†</sup>	UV-Vis	UV-NIR	UV-NIR	NIR-SWIR	UV-Vis	VIS-NIR
Photoluminescence - Fluorescence	UV-NIR	UV-Vis <sup>†</sup>	UV-NIR <sup>†</sup>	UV-NIR	NIR-SWIR	UV-Vis	VIS-NIR
Raman (SERS, SORS, CARS, Stimulated)	244-830 nm <sup>†</sup>	244 - 633 nm <sup>†</sup>	244 - 830 nm	244 - 830 nm <sup>†</sup>	1064 nm	244 - 633 nm	457 - 830 nm
Micro-Raman and Micro-fluorescence	UV-NIR	UV-Vis <sup>†</sup>	UV-NIR <sup>†</sup>	UV-NIR	NIR-SWIR	UV-Vis	VIS-NIR
Photon Counting	-	UV-Vis <sup>†</sup>	UV-Vis <sup>†</sup>	-	-	UV-Vis	-
Single Molecule Spectroscopy	-	UV-Vis <sup>†</sup>	UV-Vis <sup>†</sup>	-	-	-	-
Hyper-Spectral Imaging	-	UV-Vis	UV-Vis	-	-	-	VIS-NIR <sup>†</sup>
LIBS	-	-	-	-	-	UV-NIR <sup>†</sup>	-
Plasma Studies	UV-NIR	UV-Vis	UV-NIR	UV-NIR	NIR-SWIR	UV-NIR <sup>†</sup>	VIS-NIR

<sup>†</sup> Optimum



# iDus CCD Cameras

## Workhorse spectroscopy cameras

The iDus is Andor's most popular platform for the spectroscopy research and OEM communities, suitable for everyday spectroscopy measurements, as well as more advanced, low light detection applications.

### Comprehensive Sensor Range

CCD matrix sizes include 1024 x 127, 1024 x 256 and high resolution 2000 x 256 formats with UV and NIR optimized options. Dual AR coating (BEX2-DD) offers the best broadband detection performance and versatility.

### High Sensitivity

Best detection capabilities for experiments requiring long exposure times. The iDus range boasts sensor QE option up to 95%, TE cooling down to -100°C and state-of-the-art Ultravac™ for long-lasting performance. New Low Dark Current Deep-Depletion (LDC-DD) technology offers the best detection capabilities in the near infrared.

### Key Applications

Absorption - Transmission - Reflection  
 Raman (244, 532, 785 and 833 nm)  
 Fluorescence - Luminescence - Photoluminescence  
 Plasma studies  
 Non-linear spectroscopies



More information at [andor.com/learning](http://andor.com/learning)

**Webinar**  
 'Investigating Molecular Properties of Live Cells and Tissues'

**Technical Notes**  
 'LDC-DD technology for high sensitivity NIR spectroscopy'

'Ultravac technology and long-lasting detection performance'

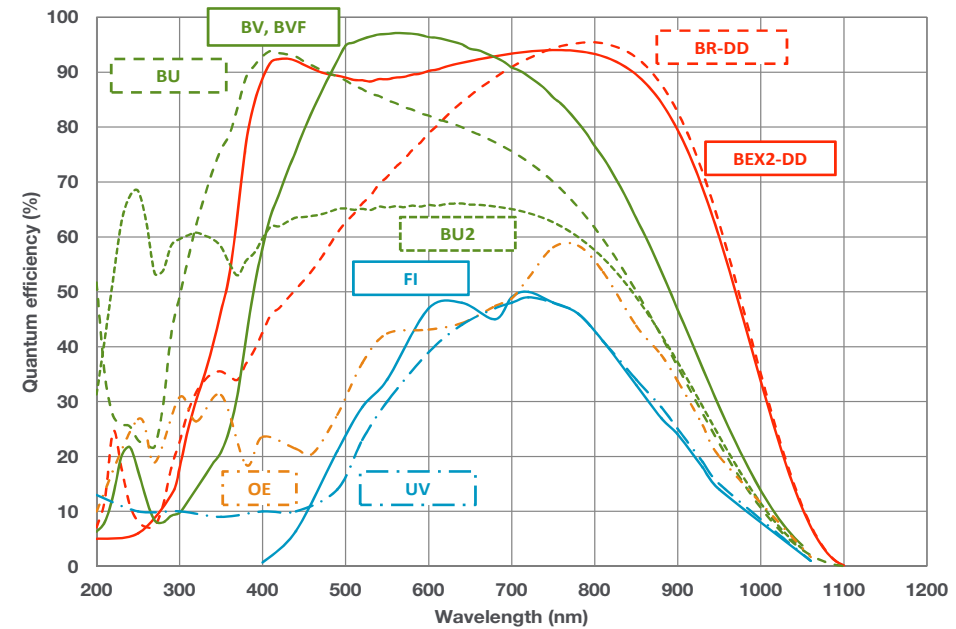

### Features

Peak QE of 95%  
 TE cooling to -100 °C  
 Ultravac™ – Guaranteed hermetic vacuum seal  
 26 or 15 μm pixels  
 Fringe suppression technology for back-thinned and back-illuminated Deep-Depletion option  
 Deep-Depletion sensor options  
 Simple opto-mechanical coupling interface  
 Simple USB 2.0 connection

### Benefits

High detector sensitivity options both in VIS and NIR regions  
 Negligible dark current without the inconvenience of LN<sub>2</sub>  
 Permanent vacuum integrity, critical for deep cooling and best sensor performance  
 Choice of high dynamic range (401 and 420 models) or high resolution (416 model)  
 Greatly reduces etaloning effect above 650 nm  
 High NIR QE, low etaloning – ideal for NIR Raman or photoluminescence. Superior broadband detection with Dual-AR technology option (BEX2-DD). Low dark-current (LDC) technology (416 model) – ideal for challenging low light NIR spectroscopy without the need for LN<sub>2</sub> cooling  
 Readily integrate with Andor Kymera and Shamrock spectrograph series  
 User friendly plug and play connection directly to the back of the camera

Model	Active pixels (μm)	Pixel size (μm)	Deepest cooling	Sensor options
DU416	2000 x 256	15 x 15	-95°C	LDC-DD
DV416	2000 x 256	15 x 15	-70°C	LDC-DD
DU401	1024 x 127	26 x 26	-100°C	FI, BVF
DU401-BR-DD	1024 x 128	26 x 26	-100°C	BR-DD
DU420	1024 x 255	26 x 26	-100°C	BU, BU2, BV, OE, BVF
DU420-Bx-DD	1024 x 256	26 x 26	-100°C	BR-DD, BEX2-DD
DV401	1024 x 127	26 x 26	-70°C	FI, BVF
DV420	1024 x 255	26 x 26	-70°C	BU, BU2, BV, OE, BVF

# iDus InGaAs

## Andor's platform for large bandpass SWIR spectroscopy

The iDus InGaAs range is a perfect complement to Andor's UV-VIS-NIR CCD camera family, extending spectral detection capabilities beyond 1.1  $\mu\text{m}$  and up to 2.2  $\mu\text{m}$ .

### Choice of Resolution and Bandpass

Both 1.7 and 2.2  $\mu\text{m}$  cut-off option offer high resolution and high capacity pixel sizes (25 and 50  $\mu\text{m}$  respectively) and large band-pass option (1024 pixels / 25.6 mm width) for extended spectral information simultaneous collection.

### TE cooling - No need for inconvenient use of $\text{LN}_2$

The Thermo-Electrically cooled, in-vacuum sensors reach cooling temperatures of  $-90^\circ\text{C}$  where the best signal-to-noise ratio can be achieved for the majority of the applications in this spectral region. Beyond this cooling point blackbody radiation from any elements facing the sensor will dominate the dark signal, and since Quantum Efficiency will be impacted with decreasing cooling temperature, TE cooling will allow access to optimum SNR performance.

### Key Applications

NIR and SWIR Absorption - Transmission - Reflection  
Raman (1064 nm)  
NIR Photoluminescence

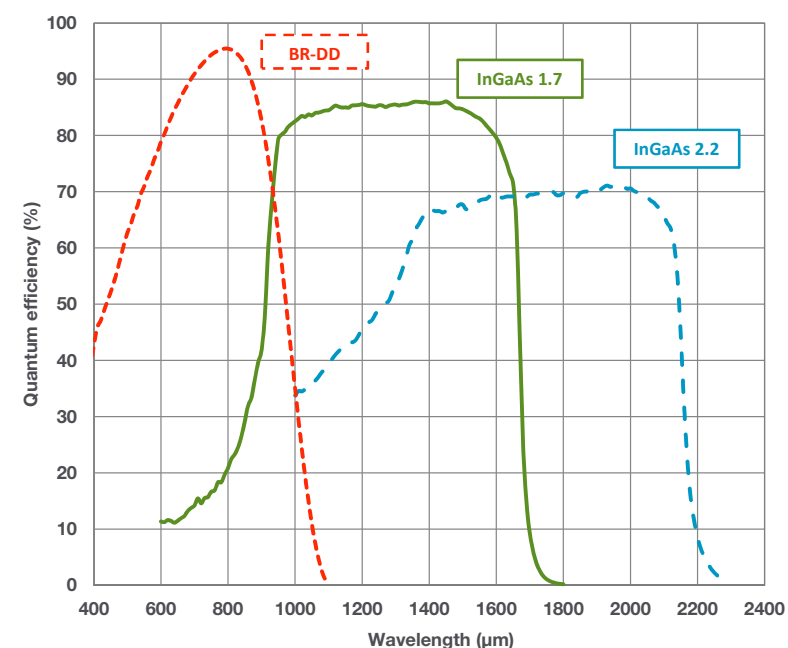
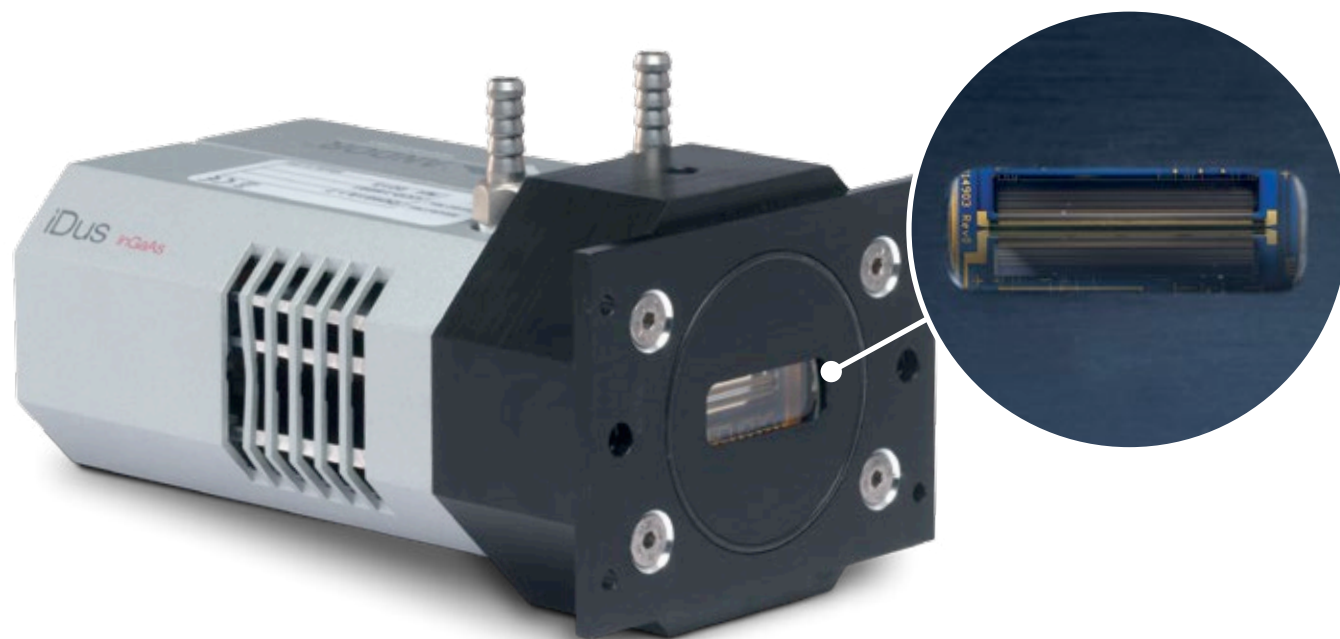

More information at [andor.com/learning](http://andor.com/learning)

### Application Note

'Raman and Photoluminescence measurements on laser lithographically written structures in Si'

### Webinar

'A TE Cooling Approach to SWIR spectroscopy'

### Features

High Quantum Efficiency  
Peak QE >80% for 1.7  $\mu\text{m}$  cut-off  
Peak QE >70% for 2.2  $\mu\text{m}$  cut-off

Typically attainable TE cooling to  $-90^\circ\text{C}$

UltraVac™

Minimum exposure time of 1.4  $\mu\text{sec}$

25  $\mu\text{m}$  pixel width option

25.6 mm wide arrays options

Software selectable output amplifiers

Simple opto-mechanical coupling interface

Simple USB 2.0 connection

### Benefits

Maximum sensitivity in the SWIR

Minimise dark current efficiently without the inconvenience of  $\text{LN}_2$

Ensures best sensor performance and protection in time

Allows study of fast transient phenomena

Optimized for high dynamic range and high resolution

Optimized for Czerny-Turner spectrograph focal plane size

Choice of High Dynamic Range (HDR) or High Sensitivity (HS)

Readily integrate with Andor Kymera and Shamrock spectrograph series

User-friendly plug and play connection directly to the back of the camera

Model	Array size (mm)	Array size (pixels)	Pixel size (W x H, $\mu\text{m}$ )	Upper cut-off wavelength ( $\mu\text{m}$ )
DU490A-1.7	12.8	512 x 1	25 x 500	1.7
DU490A-2.2	12.8	512 x 1	25 x 250	2.2
DU491A-1.7	25.6	1024 x 1	25 x 500	1.7
DU491A-2.2	25.6	1024 x 1	25 x 250	2.2
DU492A-1.7	25.6	512 x 1	50 x 500	1.7
DU492A-2.2	25.6	512 x 1	50 x 250	2.2

# Newton CCD

## The world's fastest spectroscopy CCD

When it comes to access simultaneously the best spectral resolution, acquisition rates and detection range flexibility, the Newton CCD cameras always come first.

### Fast spectral acquisitions

The Newton MHz readout platform allows spectral rates up to 1,600 spectra per second with crop mode, ideal for fast microspectroscopy chemical mapping or microfluidics analysis.

### High resolution and high dynamic range spectroscopy

13.5  $\mu\text{m}$  pixel option allows access to the highest spectral resolution, while 26  $\mu\text{m}$  pixel matrix boasts larger photoelectrons storage capacity and greater dynamic range.

### Key Applications

Absorption - Transmission - Reflection  
 Raman (244, 532, 785 and 833 nm)  
 Fluorescence - Luminescence - Photoluminescence  
 Plasma studies  
 Plasmonics  
 Fast Transient phenomena study



More information at [andor.com/learning](http://andor.com/learning)

**Application Note**  
 'Fiber Probe Based Raman spectroscopy Bio-sensor for Surgical Robotics'

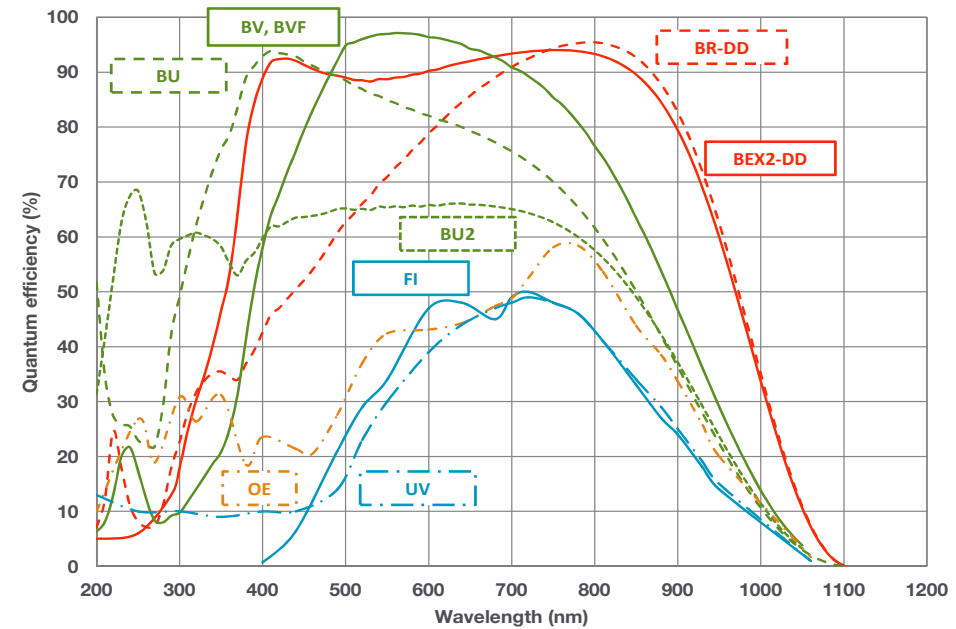

### Features

Multi-megahertz readout  
 TE cooling to  $-100^{\circ}\text{C}$   
 UltraVac™ - guaranteed hermetic vacuum seal technology  
 Down to 13.5 x 13.5  $\mu\text{m}$  pixel size  
 Crop mode operation  
 Deep-depletion sensor options  
 Software-selectable output amplifiers (DU940)  
 Simple opto-mechanical coupling interface  
 Simple USB 2.0 connection

### Benefits

High repetition rates achievable with low noise electronics - ideal for transient phenomena study  
 Negligible dark current without the inconvenience of  $\text{LN}_2$   
 Permanent vacuum integrity, critical for deep cooling and best sensor performance access  
 Optimized pixel size for achievement of high resolution spectroscopy  
 Achieve the highest possible spectral rates of over 1,600 spectra per second  
 High NIR QE, virtually etalon-free - ideal for NIR Raman  
 Superior broadband detection with Dual-AR technology option (BEX2-DD)  
 Choice of High Dynamic Range (HDR) or High Sensitivity (HS)  
 Readily integrate with Andor Kymera and Shamrock spectrograph series  
 User friendly plug and play connection directly to the back of the camera

Model	Active pixels ( $\mu\text{m}$ )	Pixels size ( $\mu\text{m}$ )	Sensor options
DU920	1024 x 255	26 x 26	BU, BU2, BV, OE, BVF
DU920-BX-DD	1024 x 256	26 x 26	BR-DD, BEX2-DD
DU940	2048 x 512	13.5 x 13.5	BU, BU2, BV, FI, UV



# iXon Ultra and Newton EMCCD

## Speed and sensitivity with no compromise

From the pioneers of EMCCD technology the newly expanded iXon Ultra and Newton<sup>EM</sup> series have brought low-light spectroscopy to a new level of performance. These cameras offer the absolute combination of sensitivity and acquisition speed for the most demanding photon starved applications.

### Highest sensitivity

EMCCDs operate by amplification of weak signal events (down to single photons) to a signal level that is well clear of the read noise floor of the camera at any readout speed. This 'on-chip' amplification process is realized without sacrificing the photon collection capability of the sensor. Back-illuminated architecture boosts QE up to 95%, while Andor's market leading TE cooling to -100°C offers unmatched dark noise performance.

### Highest spectral rates

The supercharged iXon Ultra and Newton<sup>EM</sup> allow access to the highest spectral rates without loss of sensitivity thanks to the EM amplification architecture. The iXon Ultra 888 achieves over 11,990 spectra per second (Crop Mode), while the Newton 970 allows spectral rates in excess of 1,515 spectra per second (Crop Mode) with larger simultaneous bandpass capture capabilities.

### Key Applications

Absorption - Transmission - Reflection  
 Raman (244, 532, 633 nm)  
 Raman (785 and 833 nm - VP and FI only)  
 Fluorescence - Luminescence  
 Plasma studies  
 Photon counting  
 Single molecule spectroscopy



More information at [andor.com/learning](http://andor.com/learning)

Webinar  
 'EMCCDs for spectroscopy'

Application note  
 'Spectral Flow Cytometry'

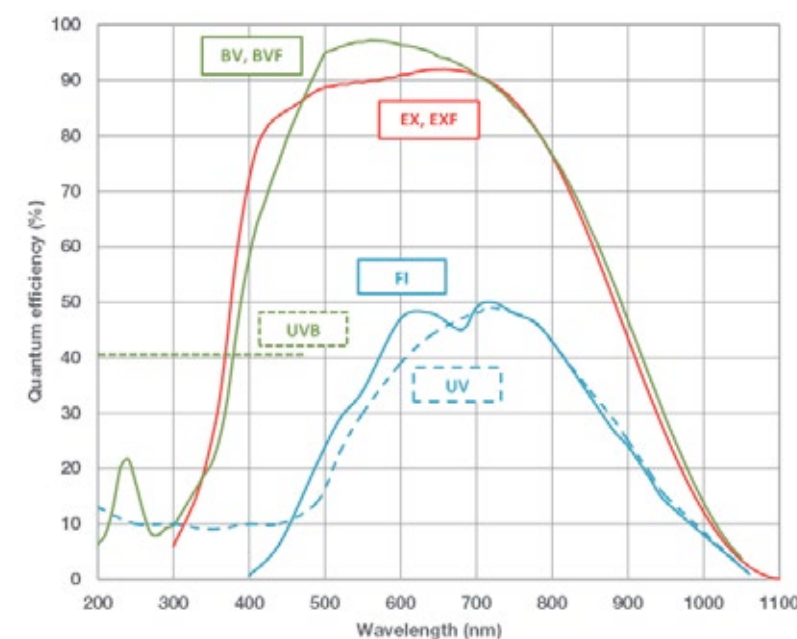

**Professor Michael Morris**  
 Professor of Chemistry,  
 University of Michigan

"In our lab the Andor NewtonEM EMCCD has enabled millisecond Raman spectroscopy and hyper-spectral Raman imaging in times as short as a minute or two. And the 1600 x 400 format is just right for spectroscopy".

### Features

<1 e- readout noise and up to 95% QE  
 Industry benchmark for fast frame and spectral rate  
 Cropped mode option  
 Ultravac™ technology and TE cooling down to -100°C  
 Software-selectable output amplifiers  
 Spectroscopy and Imaging sensor formats available  
 Seamless integration with Andor spectrographs  
 Simple USB 2.0 connection

### Benefits

'Silent' noise floor, perfectly complements high QE performance for extremely low-light detection  
 Full vertical binning up to 650 spectra per second or imaging frame rate up to 56 full-frames per second  
 Boast spectral rates in excess of few thousand of spectra per second  
 Permanent vacuum integrity, critical for deep cooling and best sensor performance access  
 Choice of High Sensitivity (low light applications) or Electron Multiplication (ultra-low light applications down to single photon)  
 25 mm wide option for maximum spectral information collection, or up to 13 mm tall option for larger vertical field of view, ideally suited for microspectroscopy. Fringe suppression options available for minimizing optical etaloning above 650 nm  
 Simple opto-mechanical coupling to Andor Kymera and Shamrock spectrograph series, with all-integrated dedicated software control  
 User friendly plug and play connection directly to the back of the camera

Model	Active pixel matrix	Pixel size (µm)	Fastest spectral rate	Data transfer interface	Sensor options
Newton 970	1600 x 200	16 x 16	1,515 sps	USB 2.0	BV, FI, UV, UVB, BVF
Newton 971	1600 x 400	16 x 16	1,515 sps	USB 2.0	BV, FI, UV, UVB
iXon Ultra 888	1024 x 1024	13 x 13	11,990 sps	USB 3.0	BV, UVB, EXF, EX
iXon Ultra 897	512 X 512	16 X 16	9,921 sps	USB 2.0	BV, UVB, EXF, EX, BVF



# NEW Zyla sCMOS

## Speed, sensitivity and dynamic range

The Zyla scientific CMOS (sCMOS) platform offers Physical and Life Science spectroscopists seamless access to a unique combination of superfast spectral rates, high sensitivity, high resolution and high dynamic range.

### Highest spectral rates

Market leading spectral rates up to 27,057, ideally suited for high resolution transient spectroscopy applications with 10's of  $\mu$ s time-resolution. Multi-track mode provides rates up to 6,000 acquisitions/second for hyperspectral imaging and dual-track, kilohertz transient absorption spectroscopy.

### High dynamic range

The Zyla sCMOS offers user-configurable, ready-to-analyze binned single spectra or multiple (multi-track) spectra. A unique 32-bit data transmission mode allows the preservation of the signal dynamic range in these extensive spectroscopy binning scenarios.

### Key Applications

- $\mu$ s-resolved transient absorption
- Fast Hyperspectral imaging
- Fast Multi-track spectroscopy

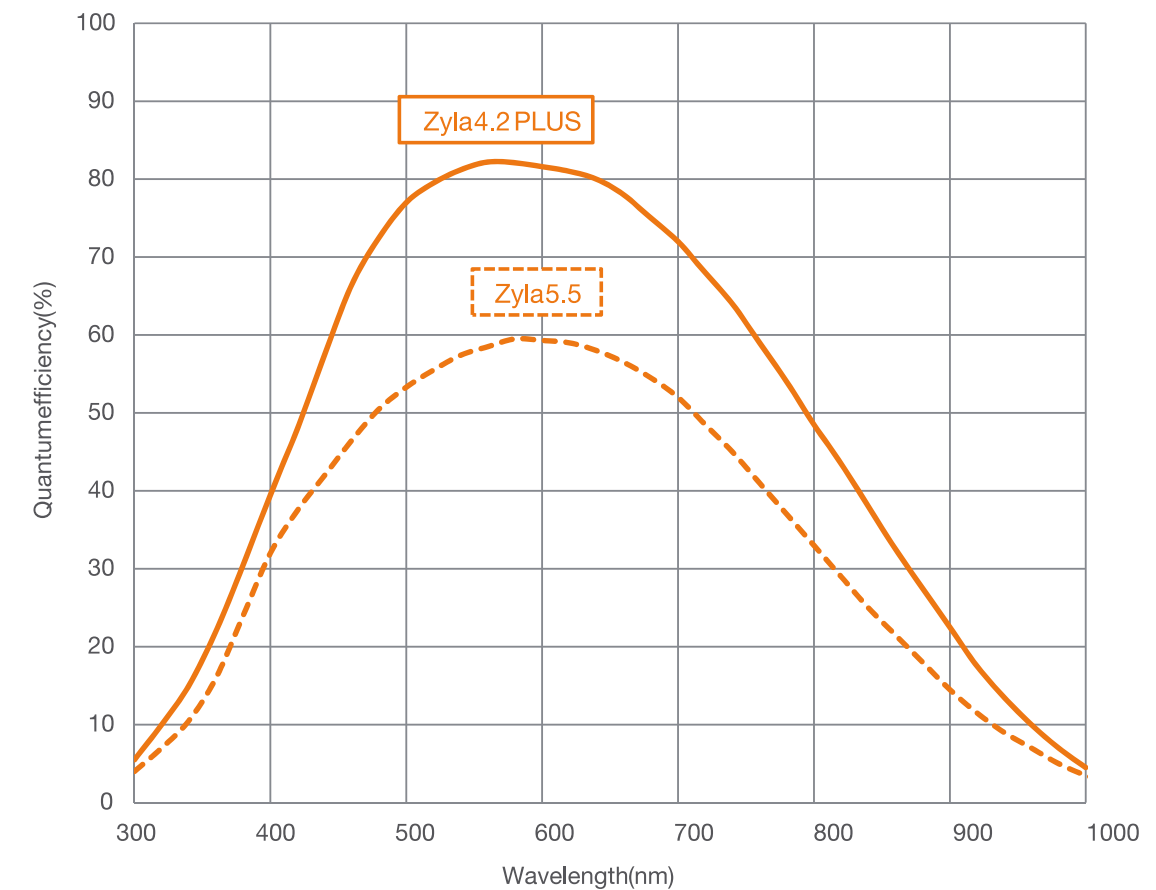

More information at [andor.com/learning](http://andor.com/learning)

**Application note**  
'sCMOS for Ultrafast Spectroscopy'

### Features

- 5.5 and 4.2 megapixel sensor formats and 6.5  $\mu$ m pixels
- ~ 1 e<sup>-</sup> Read Noise
- Up to 27,000 sps
- 12-bit and 16-bit modes
- Selectable bit-depth up to 32-bit
- 82% peak QE
- Zero etaloning in the NIR
- Better than 99.8% linearity

### Benefits

- Extremely sharp resolution over a 22 mm (Zyla 5.5) and 19 mm (Zyla 4.2 PLUS) diagonal field of view. Ideal for extended multi-track spectroscopy
- Noise floor down to 0.9 e<sup>-</sup>. Lower detection limit than any CCD
- Excellent time resolution capabilities for study of transient phenomena through user-definable Region of Interest
- 12-bit mode for smaller file size and absolute fastest frame rates through USB 3.0; 16-bit mode for full dynamic range
- Preserve dynamic range in extensive on-head binning scenarios. User-selectable data bit depth to be transmitted over the camera interface, up to 32-bit
- Highest available photon capture efficiency across visible/NIR
- Front-illuminated sensor architecture, no unwanted signal modulation in the NIR compared to back-illuminated devices
- Unparalleled quantitative measurement accuracy across the full dynamic range (> 99.9% for low light range)

# iStar Intensified CCD and sCMOS

## Industry gold standard for high-resolution, high-speed nanosecond time-resolved spectroscopy

With over 16 years of Excellence in the development of world-class, fast-gated intensified CCD and sCMOS cameras, Andor's iStar detectors are at the forefront of rapid, nanosecond time-resolved spectroscopy. They extract the very best from CCD/sCMOS sensors and gated image intensifier technologies, achieving a superior combination of rapid acquisitions rates and exceptional sensitivity down to single photon.

### Nanosecond time-resolution

Software-controlled, ultra-low-jitter onboard Digital Delay Generator (DDG™) and high-voltage, high-speed gating electronics offer < 2 ns time resolution and ultra-precise synchronisation.

### Highest spectral rates

The iStar's 5 MHz platforms and intelligent Crop and Fast Kinetics modes offer spectral rates in excess of 3,500 sps and 9,525 sps respectively. The iStar sCMOS offers spectral rates up to 4,004 sps.

### Key Applications

- Laser Induced Breakdown Spectroscopy (LIBS)
- Time-resolved fluorescence - luminescence
- Transient absorption spectroscopy
- Single molecule spectroscopy
- Time-Resolved Raman and Resonance Raman spectroscopy (TR<sup>2</sup>)



More information at [andor.com/learning](http://andor.com/learning)

### Application Notes

'Stand-off LIBS - A detection technique for explosive residues'

'High sensitivity imaging of Thomson scattering signal'



**Professor JJ Laserna**  
Professor of Chemistry,  
University of Malaga

"The Andor iStar ICCD detectors played a vital role in allowing us to develop this new mobile standoff detection system since their sensitivity allowed us to work with exceedingly low light levels. Furthermore, their refresh rates meant we could analyze spectral information at rates in excess of 10 Hz and, therefore, perform simultaneous Raman and LIBS spectroscopy in real time".



Models	Active Pixel Matrix	Effective Pixel Size (µm)	Image Intensifier Choice optic taper
DH320T (USB 2.0)	1024 x 256	26 x 26	Ø18 mm [1:1] Ø25 mm [1:1]
DH334T (USB 2.0)	1024 x 1024	13 x 13	Ø18 mm [1:1]
DH340T (USB 2.0)	2048 x 512	13.5 x 13.5	Ø18 mm [1:1] Ø25 mm [1:1]
iStar sCMOS	2560 x 2160	6.5 x 6.5	Ø18 mm [1:1] Ø25 mm [1:1]

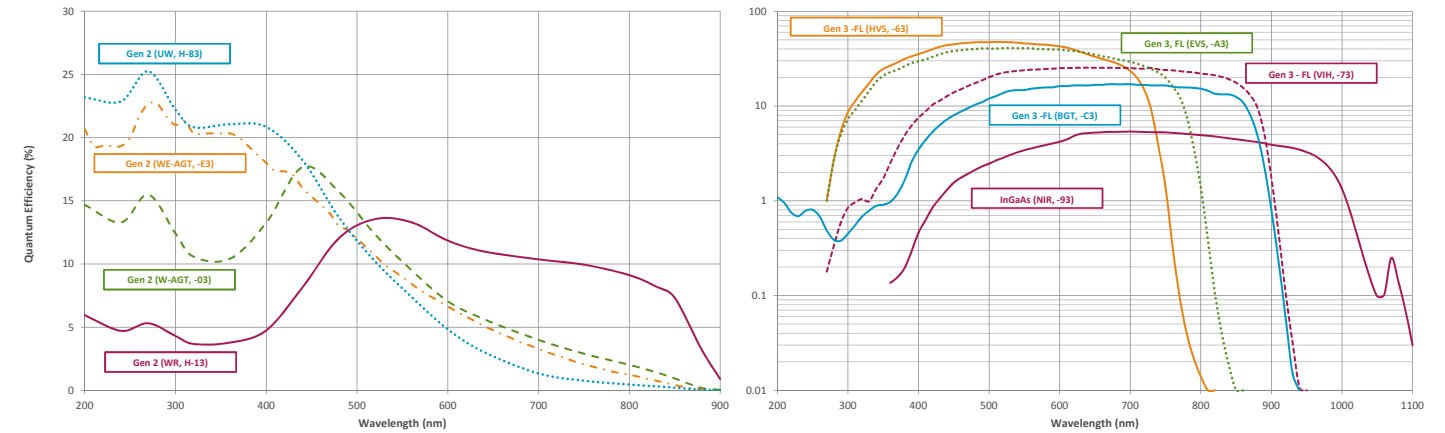

### Features

- USB 2.0 connectivity
- 5 MHz readout platform
- Comprehensive binning options - Crop and Fast Kinetic mode
- High-resolution sensors and image intensifiers
- High QE Gen 2 and 3 image intensifiers
- True optical gating < 2 ns
- Low jitter, on-board digital delay generator
- Insertion delay as low as 19 ns
- Comprehensive triggering interface
- Intelligate™
- 500 kHz sustained photocathode gating
- TE-cooling to -40°C
- Real-time control interface

### Benefits

- Industry-standard plug and play, lockable and rugged interface  
Seamless multi-camera control from single PC or laptop
- Rapid spectral rates for superior dynamic phenomena characterization
- Fully software-customizable binning sequences for highest spectral and image rates. Greater than 3,400 spectra/s continuous rates, up to 29,000 spectra/s in burst mode
- Sharpest images and spectrum definition, 100% fill factor for maximum signal collection
- Highest intensifier resolution with QE > 50% and sensitivity up to 1.1 µm
- Billionth of a second time-resolution for accurate transient phenomena study
- Highest gating timing accuracy with lowest propagation delay
- Lowest delay from signal generation to photocathode triggering
- Software-controlled 3x triggering outputs with 10 ps setup accuracy
- Intelligent and accurate MCP gating for better than 1:10<sup>9</sup> shuttering efficiency in the UV
- Maximizes signal-to-noise in high repetition rate laser-based applications
- Efficient minimization of CCD dark current and pixel blemishes
- On-the-fly software control of intensifier gain, gating and 3x outputs trigger parameters for real-time detection optimization

Photo-cathode	Type	Coverage	Peak QE (typical)	Minimum gating speed
-03	Gen 2	180-850 nm	18%	< 2 ns
-04	Gen 2	180-850 nm	18%	< 2 ns
-05	Gen 2	180-850 nm	16%	< 5 ns
-13	Gen 2	180-920 nm	13.5%	< 50 ns
-63	Gen 2	280-760 nm	48%	< 2 ns
-73	Gen 2	280-910 nm	26%	< 2 ns

Photo-cathode	Type	Coverage	Peak QE (typical)	Minimum gating speed
-83	Gen 2	180-850 nm	25%	< 100 ns
-93	Gen 3	380-1,100 nm	4%	< 3 ns
-A3	Gen 3	280-810 nm	40%	< 2 ns
-C3	Gen 3	< 200-910 nm	17%	< 3 ns
-E3	Gen 2	180-850 nm	22%	< 2 ns



# Spectrographs

Andor's technical know-how extends far beyond market-leading performance detectors with a comprehensive range of high-end spectrographs. At the heart of this portfolio are the new **Kymera** and **Shamrock** platforms, which offer ultimate flexibility and performance with their "out-of-the-box", pre-aligned and pre-calibrated approach and seamless combination with our highly sensitive spectroscopy cameras. The Mechelle 5000 is Andor's dedicated detection solution for broadband and high resolution LIBS, while HoloSpec F/1.8 offers maximum light throughput with high-density multi-track capabilities.



## NEW Kymera 193i

Intelligent, modular and compact imaging spectrograph with Active Focus technology (patented), fully motorized, RFID-tagged dual grating turret, dual detector output ports and seamless interfacing to microscopes for modular micro-Raman or micro-luminescence setups.

## NEW Kymera 328i

Intelligent and highly configurable, motorized imaging spectrograph with RFID-tagged Quad turret (on-axis rotation), Active Focus technology (patented), user-controlled TrueResX spectral resolution enhancement, dual input and output ports for ease of integration into complex experiments or microspectroscopy systems.

## Shamrock 500i

Ideal combination of high spectral resolution, imaging capabilities for multi-track acquisitions and monochromator capabilities with single point detector use for detection up to 12  $\mu\text{m}$ . Convenient USB interface, fully motorized platform and accessory range.

## Shamrock 750

Delivers the highest spectral resolution of the Shamrock range while also featuring monochromator scanning capabilities with single point detectors sensitive up to 12  $\mu\text{m}$  and plug and play, fully motorized interface.

## Shamrock 163

Rugged, compact 163 mm focal length manual spectrograph, highly configurable for general, everyday lab spectroscopy.

## Mechelle 5000

Patented optical echelle design with band-pass ranging from 200 nm to 975 nm and resolution power  $M/\Delta\lambda$  of 5,000 across the full wavelength range, all accessible in a single acquisition without the need for moving components.

## HoloSpec F/1.8

High throughput spectrograph with superb high-density multi-track spectroscopy capabilities. Robust and compact design based on low stray-light transmission virtual phase holographic (VPH) grating.

Applications	NEW Kymera series	Shamrock series			HoloSpec F/1.8	Mechelle 5000
	193i	328i	163	500i	750	
Absorption - transmission - reflection	••	••	••	•	•	
Photoluminescence - fluorescence	••	••	••	•	•	
Raman (SERS, SORS, CARS, Stimulated)	•	••	•	••	•	
Micro-Raman	•	••	•	•	•	
Micro-fluorescence	••	•	•	•	•	
Photon counting	•	•	•	•	••	
Single molecule spectroscopy	•	•	•	•	••	
LIBS	•	•	•	•	•	••
Plasma studies	•	•	•	•	••	•
Multi-track spectroscopy	•	•	•	•	••	

• Suitable •• Optimum

# NEW Kymera 193i

## Versatile, intelligent and compact imaging spectrograph

The Kymera 193i is a compact imaging spectrograph with F/3.6 aperture which, when combined with Andor's world-class range of ultra-sensitive UV-NIR and SWIR detectors, offers a 'workhorse' spectroscopy platform with superb photon collection efficiency.

### Adaptive Focus Technology (patented)

'Intelligent' motorized adaptive focus allows access to the very best spectral resolution performance in any configuration with un-matched repeatability.

### Ease of use

The RFID-based technology eXpressID™, indexed dual-grating turret, dual output port and extensive accessories range provide a highly configurable, yet compact platform to best match Academic and OEMs specific performance requirements.

### Key Applications

Absorption - Transmission - Reflection (UV-NIR and SWIR)  
Raman (244, 532, 785, 833 and 1064 nm)

Fluorescence - Luminescence (UV-NIR and SWIR)

Micro-Raman and Micro-fluorescence

Photon counting

Single molecule spectroscopy



More information at [andor.com/learning](http://andor.com/learning)

Accessory Tree  
Please refer to p37

Resolution Calculator  
[andor.com/calculators](http://andor.com/calculators)



Features	Benefits
193 mm focal length	Provides typical resolution of 0.21 nm with a 1200 l/mm @ 500 nm and up to 0.1 nm with a 2400 l/mm grating @ 300 nm
F/3.6 aperture	High throughput design suitable for photon starved applications such as single molecule microspectroscopy
USB 2.0 and i²c interface	Easy control of both spectrograph and Andor USB detectors through laptops
Dual output port	Maximum detection flexibility to cover the widest wavelength range by combining UV- Vis-NIR CCDs with SWIR InGaAs sensor
Motorized dual grating turret with eXpressID™ RFID-based technology	Precise indexing design and easy hatch access for rapid in-field upgrade User-friendly software controlled with automatic RFID-based grating turret details upload
Astigmatism-corrected optical design	Extremely high fidelity image relay of a microscope sample image through the new 15 mm wide aperture slit – imaging and spectroscopic analysis can be performed through one single optical path
Silver-protected coated optics options	Highest system throughput in the Vis-NIR-SWIR spectral region
Compact and rugged design	Suitable for space-constraint or constantly evolving Academic setups, as well as OEM instruments integration
µManager software control	Seamless control of a large range of microscopes and accessories alongside Andor Kymera and Shamrock spectrographs and spectroscopy detectors in one single software platform Simple setup of complex microspectroscopy acquisition sequences, e.g. chemical mapping.
10 Hz shutter with 40 Hz burst mode	Ideal for rapid background series acquisition and fast imaging or multi --track applications. Extended lifetime > 1 million cycles

### Key Specifications

	Kymera 193i
Aperture (F/#)	F/3.6
Focal length	193 mm
Imaging corrected optics	Yes (multi-track capabilities)
Resolution †	0.21 nm
Bandpass †	98 nm
Grating turret	Dual grating, motorized, interchangeable, RFID
Slit options	Adjustable (manual): 10 µm to 2.5 mm Adjustable (motorized): 10 µm to 2.5 mm Wide aperture: Motorized 10 µm to 2.5 mm, manual to 15 mm
Operation	Motorized, USB2.0 and i²c

† Nominal values using 1200 l/mm grating, 13.5 µm pixel and 27.6 mm wide sensor, 500 nm central wavelength.

### Looking for a manually-controlled, compact, general benchtop spectroscopy platform?

The Shamrock 163 is a manually controlled, single grating spectrograph designed for setups with lower integration and automatization / motorization constraints. More details can be found at [andor.com/163](http://andor.com/163).





# NEW Kymera 328i

## Intelligent and multi-modal spectroscopy platform

The Kymera 328 mm focal length imaging spectrograph offers a highly configurable platform, with advanced user controls to always access the very best spectral performance for routine measurements and more demanding optical setups.

### Quad Turret

Combines up to 4 gratings for greater flexibility in one single setup – more choice of resolution or blaze options at the touch of a button without grating turret swapping.

eXpressID™, RFID-based technology ensures seamless recognition and upload of all important turret parameters automatically to the spectrograph.

### TruRes™

Intelligent spectral resolution enhancement at the touch of a button, which greatly expands your spectrograph performance capabilities and range. This provides a unique ability to precisely tune the resolution needed for your applications without the need for multiple grating sets.

### Key Applications

Absorption - Transmission - Reflection (UV-NIR and SWIR)  
Raman (244, 532, 785, 833 and 1064 nm)

Fluorescence - Luminescence (UV-NIR and SWIR)

Micro-Raman and Micro-fluorescence  
Plasma studies and LIBS

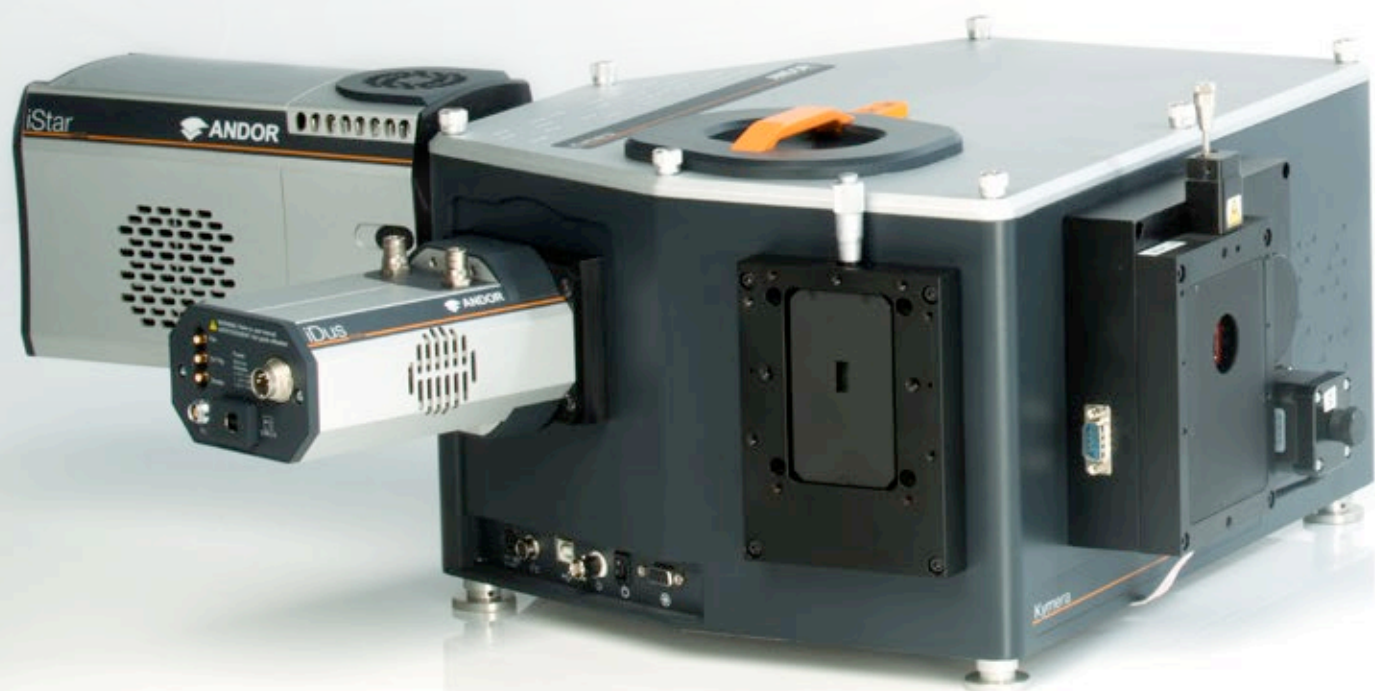

Features	Benefits
328 mm focal length, F/4.1 aperture	Ideal combination for a wide range of applications ranging from luminescence/ photoluminescence spectroscopy to more demanding, higher resolution Raman spectroscopy or plasma studies
Adaptive Focus (patented)	Intelligent and user-friendly interface for uncompromised high spectral resolution performance
Motorized quad-grating turret with eXpressID™ RFID technology	Seamless field-upgradability with precise indexing interface and user-friendly hatch access. Automatic gratings recognition and setup with embedded RFID tags - minimum user interaction.
TruRes™	True spectral resolution enhancement at the touch of a button. Fully user-controlled feature to extract the very best spectral performance for a wide range of applications without the need for multiple grating sets
Astigmatism-corrected optical design	Toroidal optics enable multi-track fiber detection and excellent sample image relay from a microscope at the grating '0' order.
Dual input and output ports	Greater setup flexibility for complex, multi-modal optical setups. Extended wavelength coverage when combining Andor UV-NIR CCD, EMCCD, ICCD and InGaAs cameras. Slit option for monochromator operation
Robust on-axis wavelength drive	High accuracy direct-drive delivers superb single-grating and grating-to-grating center wavelength repeatability down to 4 and 10 pm respectively
Protected silver coated optics options	Most efficient for NIR/SWIR detection when used in conjunction with Andor InGaAs cameras.
µ-Manager software integration	Simultaneous control of Andor cameras, spectrographs and a wide range of microscopes and accessories through 1 single software platform. Dedicated, user-friendly spectrum handling interface. Simple setup of complex microspectroscopy acquisition sequences, e.g. chemical mapping.

### Key Specifications

	Kymera 328i
Aperture (F/#)	F/4.1
Focal length	328 mm
Imaging corrected optics	Yes (multi-track capabilities)
Resolution †	0.10 nm - > 0.07 nm **
Bandpass †	61 nm
Grating turret	Quad grating, motorized, interchangeable, RFID
Slit options	Adjustable (manual): 10 µm to 2.5 mm Adjustable (motorized): 10 µm to 2.5 mm Wide aperture: Motorized 10 µm to 2.5 mm, manual to 15 mm

† Nominal values using 1200 l/mm grating, 13.5 µm pixel and 27.6 mm wide sensor, 500 nm central wavelength.

\*\* With TruRes™ option



More information at  
[andor.com/learning](http://andor.com/learning)

Accessory Tree  
Please refer to p37

Resolution Calculator  
[andor.com/calculators](http://andor.com/calculators)

# Shamrock 500i and 750

## Research grade modular high resolution spectrographs

The Shamrock 500i and 750 imaging spectrographs are research-grade, high performance, motorized and rugged platforms designed for working with demanding low-light applications, but equally suited to routine measurements.

### Versatility

The Shamrock series offers a choice of high resolution, highly modular multi-input and output platforms with a wide range of field-upgradable accessories, including indexed triple grating turrets, motorized slits and filter wheels, shutters, multi-way (multi-track) fiber optics, IR single point detectors, scanning accessories and microscope coupling interfaces.

### The right resolution for your experiment

With focal lengths of 500 and 750 mm, researchers have access to a wide range of spectral resolution performance, down to 0.02 nm for plasma spectroscopy or up to a few nanometers for broadband luminescence / photoluminescence spectroscopy. Each Shamrock comes with a choice of three software-selectable gratings (or flat mirror) that offers maximum flexibility with both broadband and high resolution options available.

### Key Applications

Absorption - Transmission - Reflection (UV-NIR and SWIR)  
 Raman (244, 532, 785, 833 and 1064 nm)  
 Fluorescence - Luminescence (UV-NIR and SWIR)  
 Micro-Raman and Micro-fluorescence  
 Photon counting  
 Single molecule spectroscopy  
 Plasma studies



More information at [andor.com/learning](http://andor.com/learning)

Accessory Tree  
Please refer to p37

Application Note  
'Spectral characterization of quantum light from an engineered Type-II sum-frequency generation process'

Resolution Calculator  
[andor.com/calculators](http://andor.com/calculators)

Features	Benefits
Pre-aligned, pre-calibrated detector and spectrograph systems	Motorized, individually factory-calibrated systems – “out-of-the-box” operation and seamless integration to experimental set-ups
Image astigmatism correction with toroidal optics (500i)	Maximum light throughput with multitrack capabilities
USB 2.0 interface	Plug and play connectivity, ideal for laptop operation alongside multi-USB camera control
Triple exchangeable grating turret	Precision kinematic mount for precise in-field upgrade
Double detector outputs	For extended wavelength coverage when combining Andor UV-VIS-NIR CCD and InGaAs cameras
Wide range of accessories available	The ultimate in modular set-up and in-field upgradability, including: <ul style="list-style-type: none"> <li>- Motorized slits and filter wheel</li> <li>- Microscope interfaces</li> <li>- Shutters</li> <li>- Fiber-optic and lens couplers</li> <li>- Multi-way fiber-optic bundles</li> <li>- Light sources and optics</li> </ul>
Monochromator capabilities	Extract best optical resolution while allowing use of single point detectors with sensitivity up to 12 $\mu\text{m}$
Gold and silver optics coating options	Most efficient for NIR detection when used in conjunction with Andor InGaAs cameras and single point detectors

Spectrograph Specifications Comparison*	Kymera 328i	500i	750
Aperture ratio (F/#)	F/4.1	F/6.5	F/9.8
Focal length (mm)	328	500	750
Wavelength Resolution (nm)	0.1 -> 0.7**	0.06	0.04
Band pass (nm)	61	40	28
Multi-track capability	Y	Y	Y

\* Nominal values using 1200 l/mm grating, 13.5  $\mu\text{m}$  pixel and 27.6 mm wide sensor, 500 nm central wavelength.

\*\* With TruRes™ option



# HoloSpec F/1.8 and F/1.8i

## High throughput imaging spectrograph

The Andor HoloSpec is the ideal platform for collecting more light and achieving better and faster signal-to-noise ratio. Its rugged and compact design makes it an ideal tool for challenging industrial or in-the-field applications, while still offering research-grade performance suitable for academic research.

### Superior light gathering power - when every photon counts

The Andor HoloSpec spectrograph series is designed for very high light collection efficiency with a large F/2 aperture and high throughput optical design based on Volume Phase Holographic technology. It provides a perfect match to Andor's low noise CCD, EMCCD and ICCD detectors, offering the most sensitive and versatile detection solution on the market for Visible or Near-Infrared spectroscopy.

### High density multitrack spectroscopy

The on-axis transmission design greatly minimizes scattered light and channel crosstalk when working with high density multi-track fiber optic assemblies, allowing simultaneous acquisition of over 200x individual channels at a time with large area CCDs.

### Key Applications

Raman, Luminescence and Plasmonics microspectroscopy mapping - e.g. bio-samples, carbon nanostructures, light harvesting complex or organic light-emitting diode (OLEDs)  
 Photoluminescence - e.g. Quantum Dots  
 Cathodoluminescence  
 Standoff chemical detection - e.g. explosive or chemical warfare agents  
 Microfluidics - e.g. flow cytometry  
 On-line process control  
 Real-time medical diagnosis - e.g. cancer screening



More information at [andor.com/learning](http://andor.com/learning)

#### Application Notes

'Spectral Flow Cytometry expanded to Visible and Near Infrared Fluorescence spectroscopy'

'Hyphenated Raman - OCT Clinical Diagnosis of Skin Cancers'

Resolution Calculator [andor.com/calculators](http://andor.com/calculators)

Features	Benefits
High collection efficiency ultrafast F/1.8 aperture	Up to 6.5 times better light collection efficiency than traditional 1/3 <sup>rd</sup> m Czerny-Turner designs
On-axis imaging-corrected design	100% light collection from NA=0.22 fiber optics
High throughput optical design	Superb optical aberration correction across a large focal plane for superior spatial resolution and high density, low crosstalk multi-track (multi-fibers) acquisitions
Low scattered light	Gather more photons per pixel for superior signal-to-noise ratio
Compact and rugged design	High transmission volume phase holographic (VPH) gratings with state-of-the art optics - maximum optical efficiency for visible or near-infrared range
Easily interchangeable accessories	'Smooth' sinusoidal refractive index VPH gratings profile greatly minimizes stray light - maximizes detection dynamic range and signal-to-noise
Specialized Raman grating options	Pre-aligned and pre-calibrated, "out-of-the-box" operation, excellent thermal stability and easily transportable
Optional integrated Rayleigh filtering unit	'Snap-in' accessories, including precision slits and pre-aligned grating assemblies
Specialized Raman grating options	Optimized for Stokes/Anti-Stokes, 'low-frequency' or 'high frequency' Stokes operation, 514.5 to 830 nm laser options
Optional integrated Rayleigh filtering unit	Fully-enclosed SuperNotch Plus Kaiser filter compartment with user-friendly external adjustment

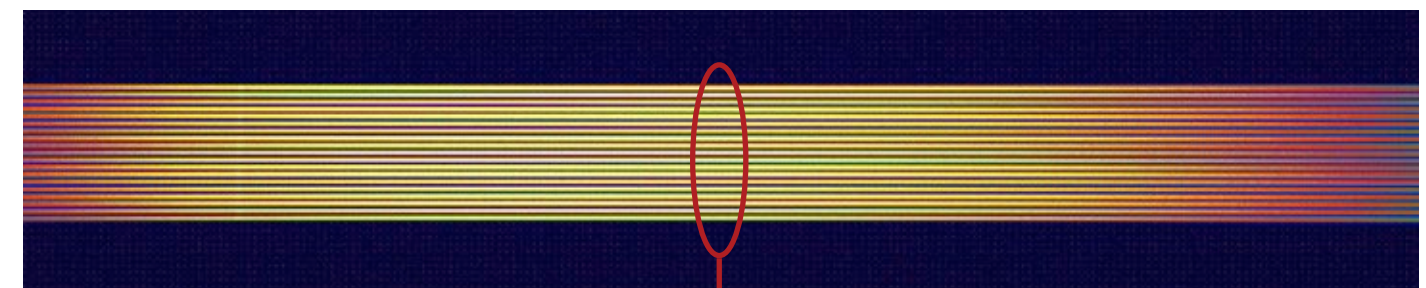
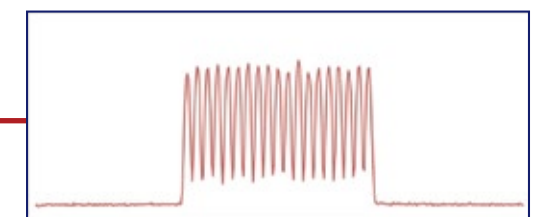

Image and cross-section of a high density 19 x 100 μm core (125 μm inc. cladding) fiber optics bundle at the output focal plane of a HoloSpec F/1.8 'visible' model. Source is a broadband Deuterium-Tungsten captured from 532 - 609 nm with a Newton EMCCD DU971P-BV.



Resolution and Bandpass	F/1.8 VIS <sup>§</sup>		F/1.8 NIR <sup>§</sup>	
	532 High Dispersion	532 Low Dispersion	785 High Dispersion	785 Low Dispersion
Resolution (nm) <sup>*1</sup>	0.07	0.17	0.1	0.3
Bandpass (nm) <sup>*2</sup>	32	83	47	152

<sup>§</sup> For F/1.8i model, typical resolution should be multiplied by 1.2 due to the optical magnification of the system

<sup>\*1</sup> With 50 μm input slit and 13.5 μm pixel CCD e.g. Newton DU940

<sup>\*2</sup> With 27.6 mm wide CCD e.g. Newton DU940

# Mechelle 5000

## High-band pass echelle spectrograph

Andor's Mechelle 5000 spectrograph is based on the echelle grating principle with a patented optical design provides extremely low crosstalk and maximum resolution compared with other spectrographs. It is designed to operate with both Andor's iKon CCD camera and the iStar DH334T intensified camera in applications including LIBS and plasma studies.

### Simultaneous high bandpass and resolution

The Echelle spectrograph design allows capture of multiple grating orders in one single acquisition, leading to a spectral coverage of over 750 nm from 200 – 975 nm, while also offering a constant high resolution power up to 6,000 across the entire wavelength range.

### Key Applications

Laser Induced Breakdown Spectroscopy (LIBS)  
Plasma studies



More information at [andor.com/learning](http://andor.com/learning)

### Application Note

'Automated 2D elemental mapping by Laser-Induced Breakdown Spectroscopy'



Echellogramme



Example of Mercury-Argon spectrum

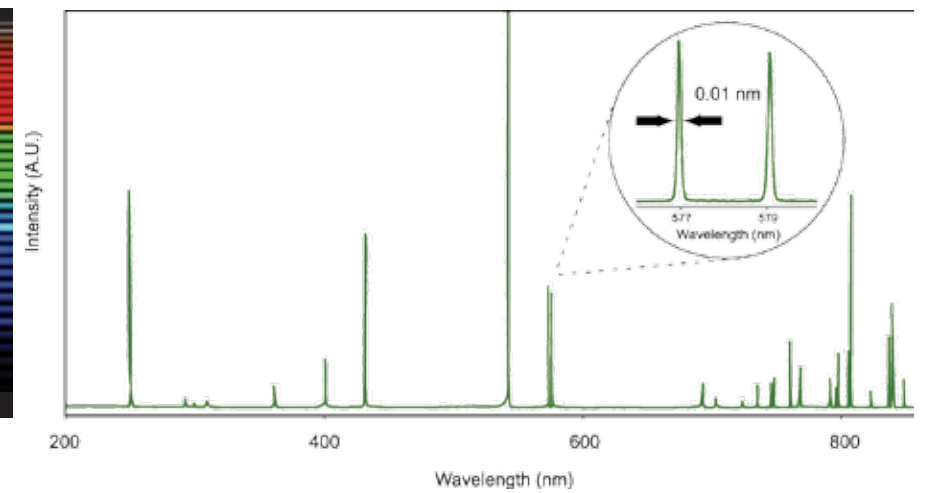

### Features

- Compact and robust design with no moving components
- Patented optical design
- Auto-temperature correction
- N<sub>2</sub> purged
- Pre-aligned detector/spectrograph solution
- Low F/number
- Wide range of accessories available

### Benefits

- Ideal for lab and OEM system integration
- Ensures maximum resolution and extremely low cross-talk
- Corrects for the variation of prisms optical refractive index with temperature
- Enables maximum throughput in the UV region
- Enables fast and efficient experimental set-up
- Highly efficient light collection
- Including fiber optics, slits, aiming laser, collector/collimator and calibration lamps

### Spectrograph Specifications

Wavelength range (nm)	200 - 975
Focal length (mm)	195
Aperture	F/7
Spectral resolution ( $\lambda/\Delta\lambda$ ) (corresponding to 3 pixels FWHM)	6,000
Wavelength accuracy	Better than $\pm 0.05$ nm
Optical adjacent order cross-talk	Better than $1 \times 10^{-2}$
Stray light	Better than $1.5 \times 10^{-4}$



# Accessories

Modularity is Andor's ethos when it comes to spectroscopy systems, because every researcher's requirements are unique. This translates into the need for an extensive range of state-of-the-art accessories, from light collection to signal analysis and detection.

Andor combines over 25 years of expertise in the fields of optics, mechanics and electronics, from designing complex interfaces to extract the very best of its market leading detectors and spectrographs, to working alongside key suppliers worldwide. The result is Andor's ability to offer a comprehensive range of high performance dedicated or extremely versatile accessories, ranging from multi-cord fiber optics to sample chamber, light sources, gratings, slits and third party instruments interfaces including microscopes and VUV monochromators.

## Spectral information tailoring

Selection of low and high density gratings with blaze from UV to NIR, interchangeable fixed, manual and motorized slits, mechanical shutters and filter wheels that accommodate neutral density, Raman edge and long/short pass types.

## Spectrograph/monochromator accessories

Delivers the highest spectral resolution of the Kymera and Shamrock ranges while also featuring monochromator capabilities and plug and play, fully motorized interface.

## Signal input coupling interfaces

Range of opto-mechanical couplers including fiber optics X-Y adjusters, F/number matchers, sample chamber and UV to NIR-optimized lenses. Andor's portfolio for modular microspectroscopy includes C-mount compatible flanges, wide-aperture slit, modular cage systems and a range of microscope feet for optical height matching.

## Light sources

Spectral calibration lamps including "pen-ray" style Mercury, Argon, Neon or Xenon lamps, and Deuterium and Xenon arc lamps for radiometric calibration or absorption measurements.

## Fiber optic

Multi-leg fiber ferrules "round-to-line" configurations, for maximum light collection along spectrograph entrance slit and multi-channels simultaneous acquisition with imaging-optimized spectral instruments.



**More information at**  
[andor.com/learning](http://andor.com/learning)

**Accessory Trees**  
Please refer to p37

**Grating Selection**  
Please refer to p32

**Fiber Optics**  
Please refer to p38

**Microspectroscopy**  
Please refer to p40





# Software

Research spectroscopy applications demand powerful software tools that provide everything from seamless configuration of spectrographs and cameras to actual data acquisition optimization. Andor's Solis software and Software Development Kit (SDK) offer a truly powerful, yet user-friendly modular approach to spectroscopy.

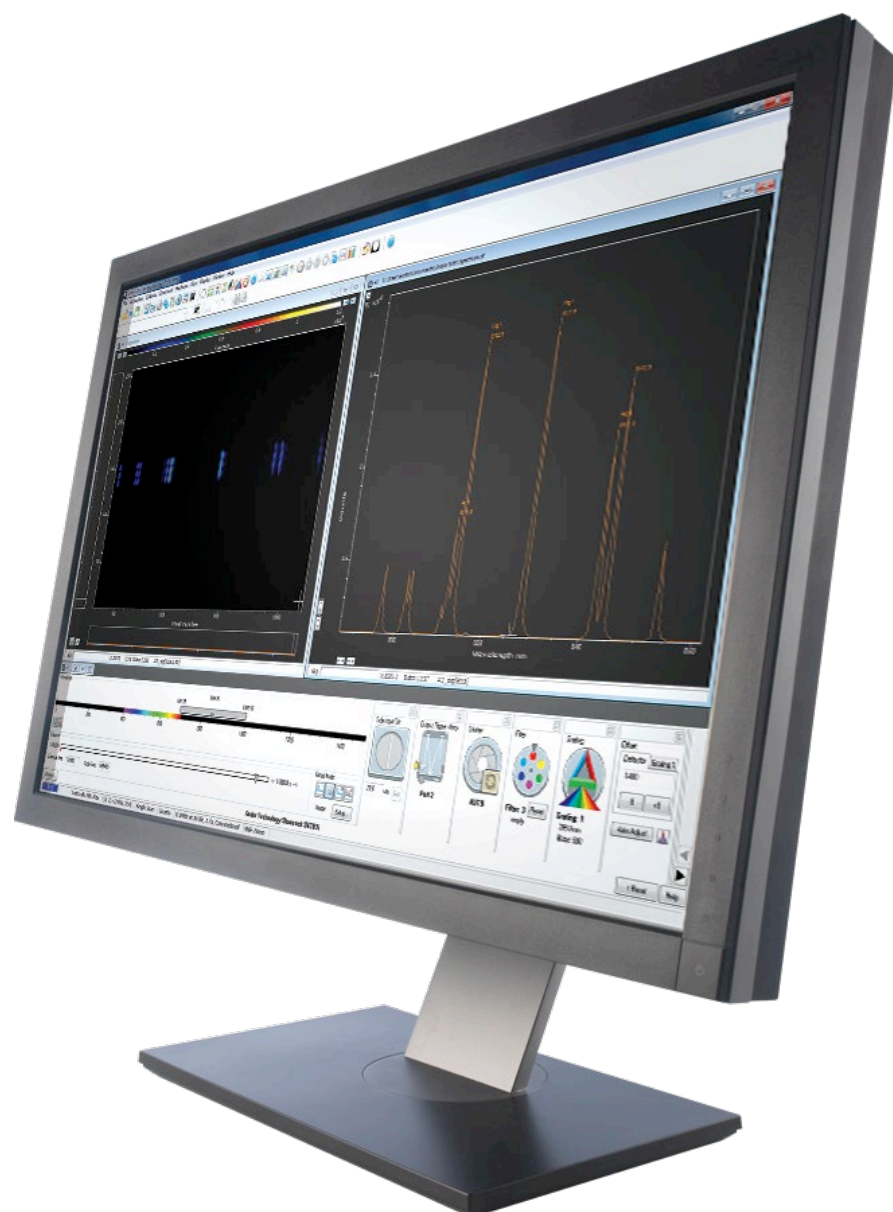

## Software Development Kit (SDK)

Andor SDK features a comprehensive library of camera and spectrograph controls, ideally suited for complex experiments integration including third party hardware control and SDK - i.e. microscope motorized stage or light sources - and user specific data analysis protocols. Available as 32 and 64-bit libraries for Windows (7, 8, 8.1 and 10) and Linux, the SDK provides a suite of functions that allow configuration of the data acquisition process in a number of different ways. The dynamic link library can be used with a wide range of programming environments including C/C++, C#, VB.NET, Labview and Matlab.



## Solis for Spectroscopy

Modular Raman spectroscopy, Laser Induced Breakdown Spectroscopy (LIBS) and Plasma diagnostics are only a few examples of applications where Andor Solis Spectroscopy allows researchers to truly focus on their own experimental challenges. With its unique interactive real-time control interface, users can optimize system optical performance through wavelength, gratings and entrance/exit slits selection at the touch of a button, while accessing all key detectors acquisition parameters to optimize the quality of the signal. Solis also features a comprehensive range of acquisition options including ultrafast kinetic series and "Crop mode" operation, simultaneous multi-track recording, photon-counting mode, and time-resolved series capture for lifetime fluorescence studies.



## Solis Scanning

With detection capabilities ranging from UV to the Long Wave IR (LWIR) region through a comprehensive range of single point detectors - including PMTs, PbS and MCT, Solis Scanning offers a dedicated platform for scanning applications. Spectrograph/monochromators, detectors, data acquisition unit, lock-in amplifier / chopper and motorized accessories can all be conveniently synchronised through a series of intuitive interfaces. A single software package features a comprehensive step-by-step experiment building interface for parametrizing and synchronizing all components of the detection chain.

Complex scanning sequences involving multiple gratings, filters and up to two monochromators for fluorescence measurements - including a tuneable light source setup - can be seamlessly captured prior to acquisition start and executed without further intervention of the user. Solis Scanning can also handle multiple detectors control and data display for Absorption - Transmission - Reflection spectroscopy, while offering post-acquisition mathematical data processing ranging from simple ratios and lifetime measurements to fast phenomena analysis.



## µManager

### µManager

New

This third party software platform offers extensive control of microscope and microscope accessory devices as well as Andor's Kymera 193i and 328i spectrographs and spectroscopy cameras, allowing simple control of complex microspectroscopy experiments.



More information at  
[andor.com/software](http://andor.com/software)



# Spectrograph Accessories

Access to a wide range of detection system configurations is the basis of Andor's modular approach to spectroscopy. That is why Andor is continuously and dynamically expanding its range of field-upgradable accessories to meet the ever-growing demand from researchers. This now includes enhanced options for combining microscopy and spectroscopy.

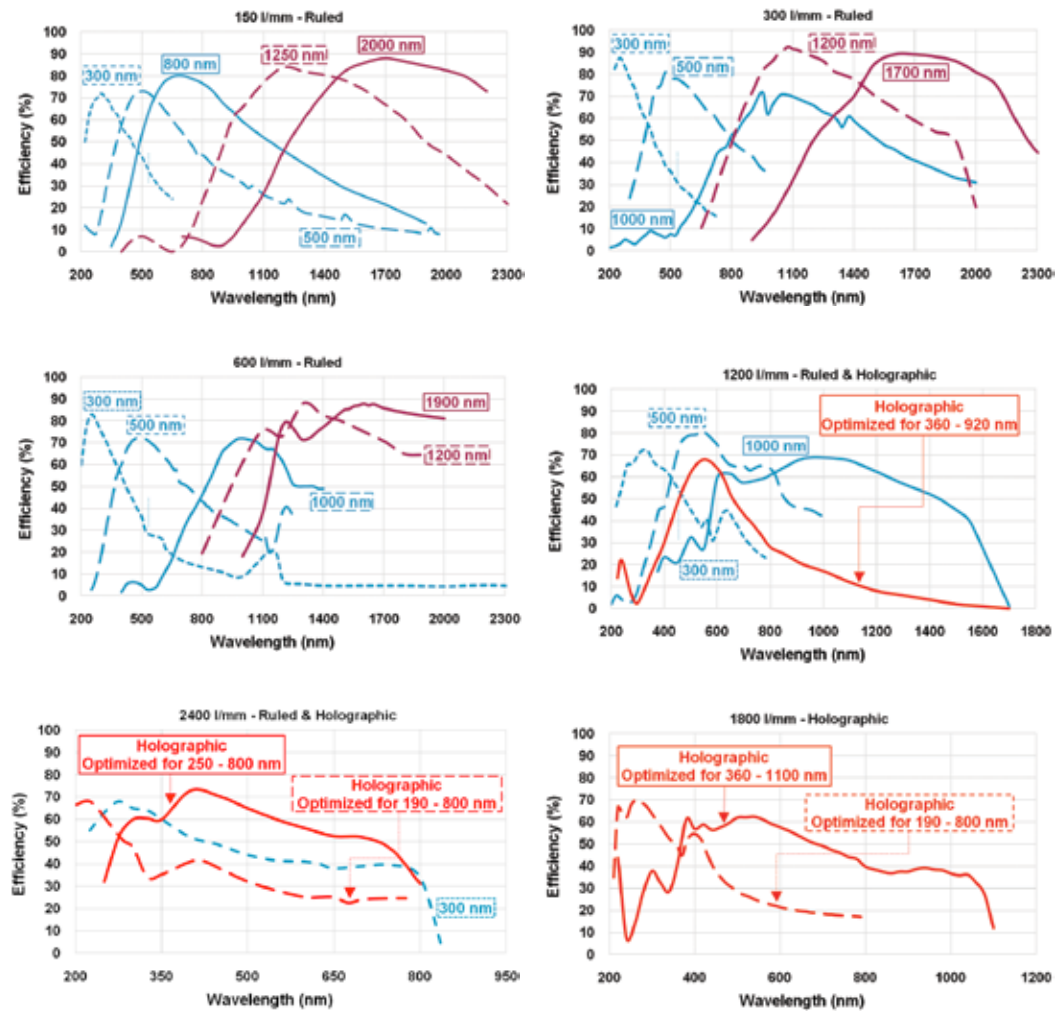

## Looking for light coupling interfaces to Andor spectrographs?

Get an instant view of all standard accessories and follow the configuration trees to check for compatibility.

## Can't see exactly what you are looking for?

Do you want a grating with a different groove density or a different blaze angle, FC connection instead of SMA or custom light coupling between microscope and spectrograph? Andor's experienced and dedicated Customer Special Request (CSR) team will be eager to discuss your specific needs.



More information at [andor.com/learning](http://andor.com/learning)

Specification sheets [andor.com/spectrographs](http://andor.com/spectrographs)

Resolution calculator [andor.com/calculators](http://andor.com/calculators)

## Kymera 193i/328i and Shamrock 500/750 accessory tree overview

Kymera 193i/328i and Shamrock 500/750

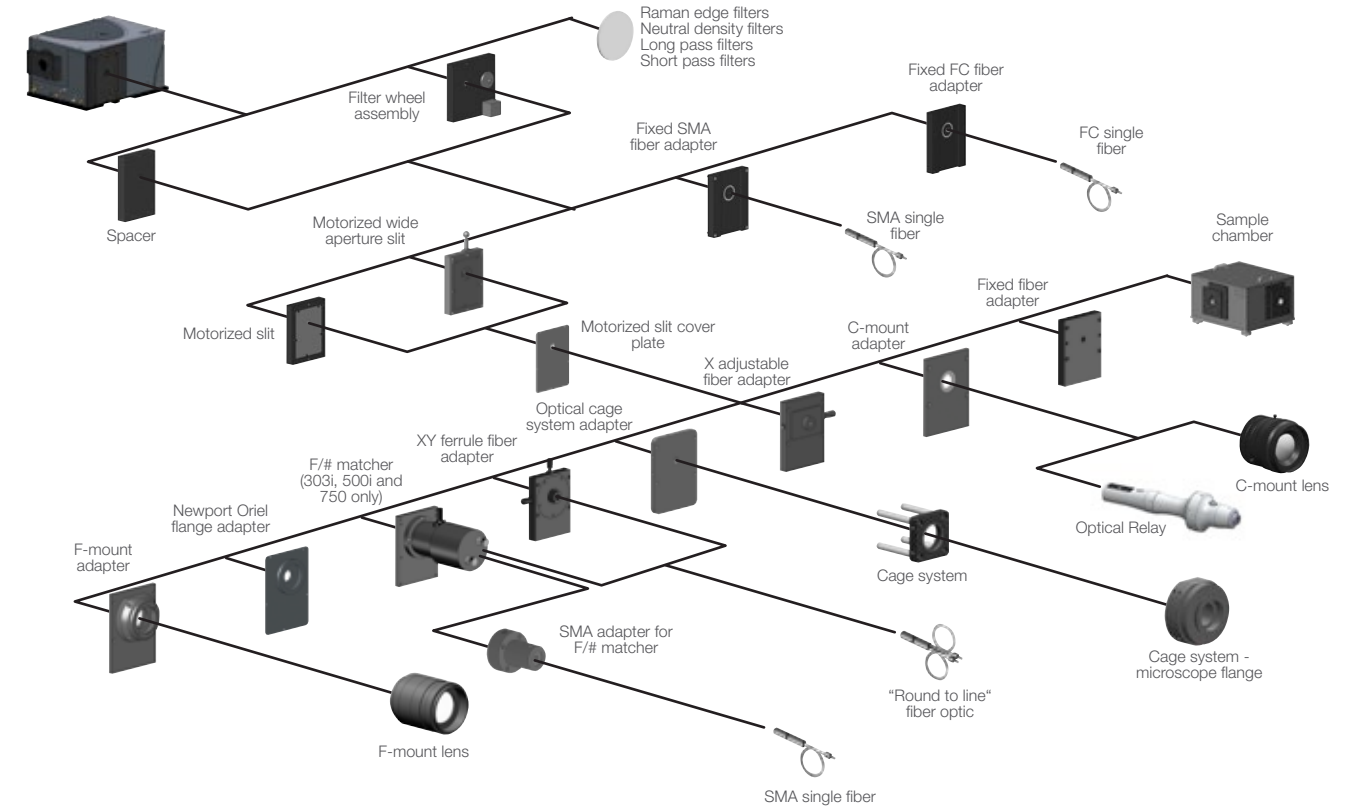

## Shamrock 163 accessory tree overview

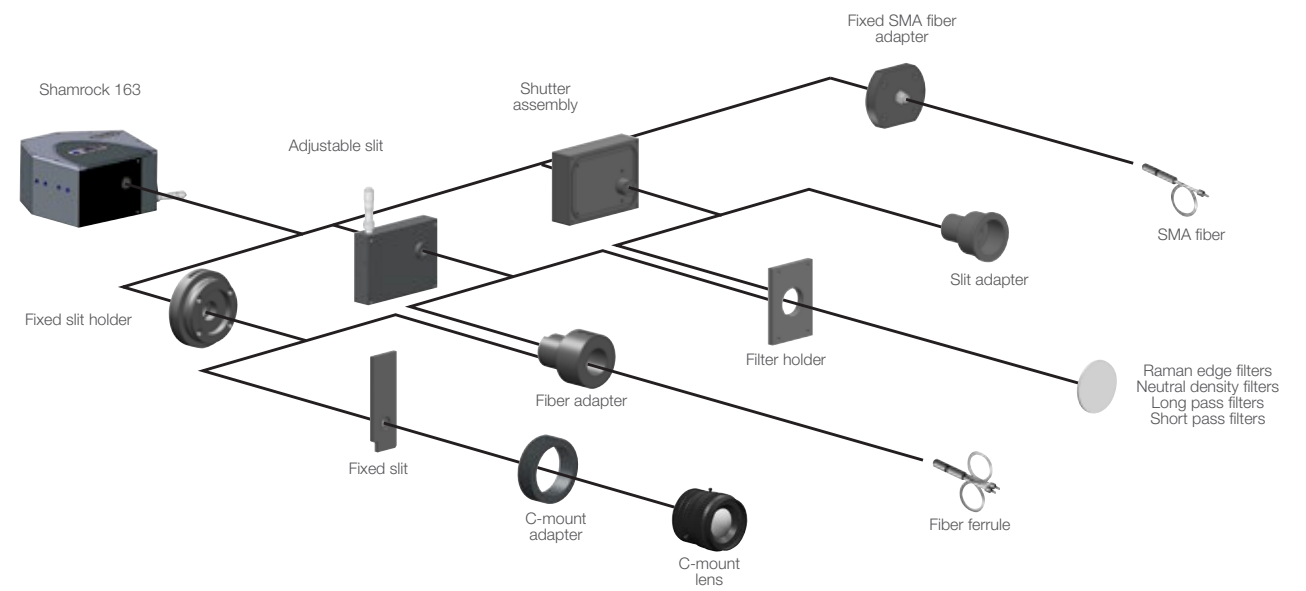

# Fiber Optics Solutions

Fiber optic is one of the most convenient ways to collect and transport light from an experimental set-up to a spectrograph-based detection solution. Andor's series of "round-to-line", multi-core fiber optic bundles maximizes the signal collection by positioning the multiple cores alongside the spectrograph entrance slit. Andor works with industry leading manufacturers to deliver solutions which meet any user requirement.

Fiber Reference	Number of legs	Fiber Core Diameter	Optimized Wavelength	Number of fiber cores per leg	a (mm)	b (mm)	c (mm)
SR-OPT-8002	1 way	100 μm	VIS-NIR (LOH)	19	2.38	2.38	-
SR-OPT-8007	2 way	100 μm	VIS-NIR (LOH)	7	2.95	0.875	1.2
SR-OPT-8008	4 way	100 μm	VIS-NIR (LOH)	3	5.625	0.375	1.375
SR-OPT-8009	5 way	100 μm	VIS-NIR (LOH)	3	5.375	0.375	0.875
SR-OPT-8013	3 way	100 μm	VIS-NIR (LOH)	7	5.625	0.875	1.50
SR-OPT-8014	1 way	100 μm	UV-VIS (HOH)	19	2.38	2.38	-
SR-OPT-8015	2 way	100 μm	UV-VIS (HOH)	7	2.35	0.875	1.2
SR-OPT-8016	3 way	100 μm	UV-VIS (HOH)	7	5.625	0.875	1.5
SR-OPT-8017	4 way	100 μm	UV-VIS (HOH)	3	5.625	0.375	1.375
SR-OPT-8018	5 way	100 μm	UV-VIS (HOH)	3	5.375	0.375	0.875
SR-OPT-8019	1 way	200 μm	VIS-NIR (LOH)	19	4.66	4.66	-
SR-OPT-8020	2 way	200 μm	VIS-NIR (LOH)	7	5.43	1.745	2.0
SR-OPT-8021	3 way	200 μm	VIS-NIR (LOH)	3	5.635	0.735	1.715
SR-OPT-8022	4 way	200 μm	VIS-NIR (LOH)	3	5.88	0.735	1.715
SR-OPT-8024	1 way	200 μm	UV-VIS (HOH)	19	4.66	4.66	-
SR-OPT-8025	2 way	200 μm	UV-VIS (HOH)	7	5.43	1.715	2.0
SR-OPT-8026	3 way	200 μm	UV-VIS (HOH)	3	5.635	0.735	1.715
SR-OPT-8027	4 way	200 μm	UV-VIS (HOH)	3	5.88	0.735	1.715

a. Total fiber optic bundle height   b. Individual channel height (live fibers)   c. Spacing between individual channels (dead fibers)

Generic fiber optic bundle configuration

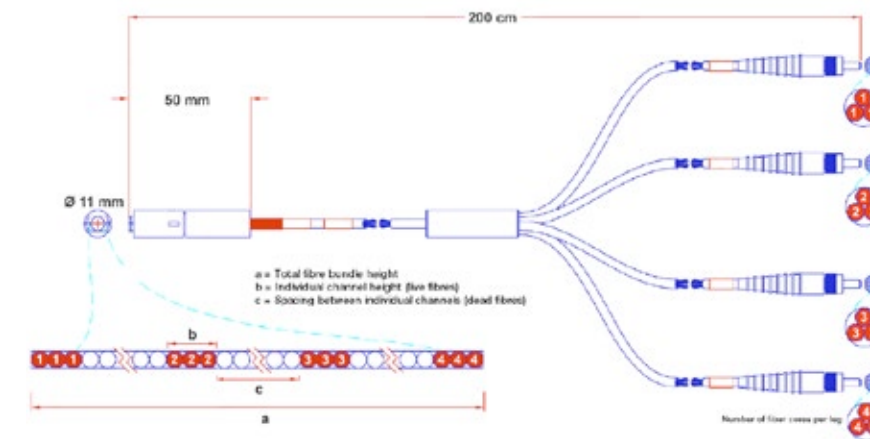

## Key Specifications

UV-Vis and Vis-NIR optimized options  
 Numerical Aperture = 0.22  
 100 and 200 μm fiber core options  
 From 1 to 5 leg options as standard  
 Standard SMA connectors to Ø 11 mm  
 Andor ferrule  
 2 m overall length – setup convenience  
 and minimum transmission losses  
 Re-enforced shield and ruggedized  
 connectors  
 Compatible with Andor Kymera and  
 Shamrock F/number matchers and X-Y  
 adjusters

## Have you found what you are looking for?

Need a different fiber core size? A longer overall cable? FC connectors? Additional channels or legs? Please contact your local Andor representative to discuss your specific needs.



# Microspectroscopy

## Modular approach to combined microscopy and spectroscopy

Adding structural and chemical spectral analysis to Microscopy images of bio-samples such as cells and proteins, or materials such as polymers or semi-conductors, is of ever increasing demand amongst the research community. Andor's range of modular interfaces feature cage systems couplers, allowing endlessly configurable connections between Kymera and Shamrock spectrographs and a wide range of market leading microscopes such as Nikon, Olympus, Leica and Zeiss. The "wide-aperture" slit opens the door to a single setup with a single detector to image the sample, whilst allowing spectral information collection through the same optical path from the microscope.

### Key Applications

- Micro-Raman
- Micro-fluorescence - luminescence
- Micro-LIBS



From sample imaging... to analytical information

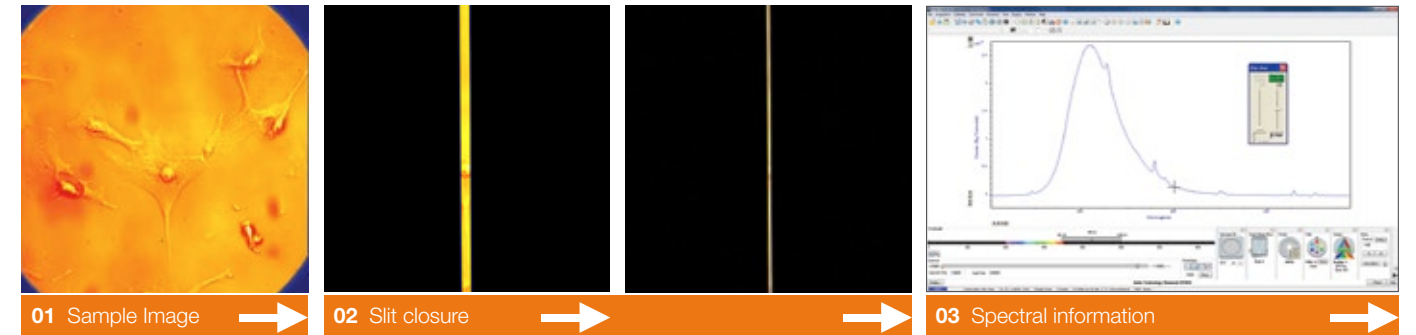

Features	Benefits
C-mount interfaces	Seamless integration of Kymera and Shamrock spectrograph-based systems to market leading upright and inverted microscopes
Microscope feet	Microscope left or right inverted output options – matches precisely Kymera and Shamrock spectrograph optical height for accurate opto-mechanical coupling
Wide-aperture slit	Up to 12 mm field of view - Andor's imaging-optimized spectrographs allow high quality sample image relay, without compromise in spectral information collection through the same optical channel
Thorlabs or Linos cage systems compatible interfaces	Fully user-configurable optical setups for Micro-Luminescence and Micro-Raman – compatible with 16, 30 and 60 mm versions
EMCCD compatible	Andor Newton <sup>EM</sup> and iXon platforms offer a unique combination of single photon sensitivity and high spectral rate and frame rate for challenging low-light spectroscopy
Software Development Kit	Enables seamless integration with third party hardware and SDK under Labview, C/C++ and Visual Basic

	Adjustable spectrograph feet set	Microscope fixed feet set	Microscope to cage system adapter
Leica DMI4000 / 6000B		TR-LCDM-MNT-150	TR-LCDM-CAGE-ADP
Leica DMI 8	<b>Kymera 193i/328i</b>	TR-DMI8-MNT-150	TR-DMI8-CAGE-ADP
Nikon Eclipse Ti series	SR-ASM-0098	TR-NKTI-MNT-150	TR-NKTI-CAGE-ADP
Nikon TE-2000	<b>Shamrock 500i/750</b>	TR-NKTE-MNT-150	TR-NKTE-CAGE-ADP
Olympus IX71/81 (left port)	SR-ASM-0082	TR-OLIX-MNT-150	TR-OLIX-CAGE-ADP
Olympus IX73/83		TR-OL83-MNT-150	TR-OL83-CAGE-ADP
Zeiss Axiovert 200		TR-ZSAV-MNT-150	TR-ZSAV-CAGE-ADP
Zeiss Axio Observer		TR-ZAXO-MNT-150	TR-ZAXO-CAGE-ADP

# Scanning Accessories

## The perfect complement to Andor's multi-channel detector portfolio

These accessories provide a perfect complement to Andor's extensive range of market leading CCD, ICCD, InGaAs and EMCCD detectors. Shamrock and Kymera spectrograph double detector output configurations allow detection from 180 nm to 12  $\mu\text{m}$  with one single setup. A Solis Scanning software platform provides a dedicated single interface for seamless setup and synchronizing of single point detectors, spectrographs, data acquisition unit and lock-in amplifiers, with an intuitive interface for complex experiment acquisition sequences.



More information at [andor.com/learning](http://andor.com/learning)

Specification sheets [andor.com/spectroscopy](http://andor.com/spectroscopy)

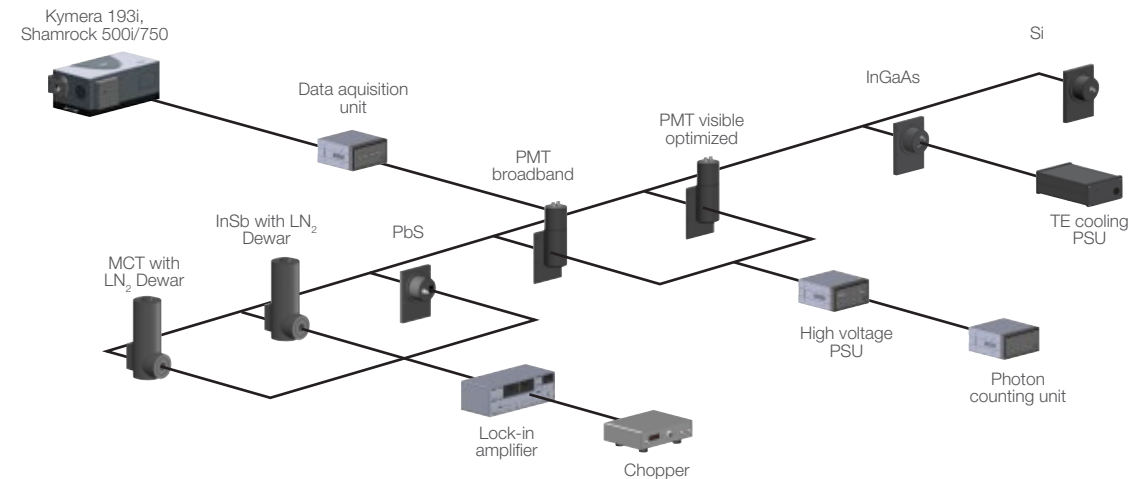

Features	Benefits
Wide range of single point detectors	Selection of PMTs, silicon photodiode, InGaAs, PbS, InSb and MCT detectors for sensitivity up to 12 $\mu\text{m}$
Seamless integration with Kymera and Shamrock spectrographs	All detectors include spectrograph flange for easy opto-mechanical coupling
Gold/silver optics coating options	Ensures monochromator maximum throughput in the infrared region of the spectrum – MCT and InSb detectors include gold-coated focusing optics for maximum detection efficiency
Dedicated software interface	1) Individual set-up interface for SPD, HV power supplies, photon counting and data acquisition units, lock-in amplifiers and monochromators, 2) Experiment builder interface for complex experiments involving sequential selection of gratings, filters or monochromators, 3) Dedicated GUI for data display and manipulation, including mathematical operators and FFT options
Three acquisition modes	Versatile interface for scanning monochromator, time-resolved and photon counting
USB 2.0 connectivity	Plug and play data acquisition unit – allows connection to laptops alongside USB-controlled Kymera and Shamrock monochromators

Part reference	Detector type	Wavelength coverage	Active area (mm)	Cooling
ACC-SR-ASM-0042	MCT *	2-12 $\mu\text{m}$	1 x 1	LN <sub>2</sub>
ACC-SR-ASM-0043	InSb *	1-5.5 $\mu\text{m}$	Ø2	LN <sub>2</sub>
ACC-SR-ASM-0045	PbS	0.8-2.9 $\mu\text{m}$	4 x 5	Room temperature
ACC-SR-ASM-0044	InGaAs	0.8-1.9 $\mu\text{m}$	Ø3	-40°C TE cooling
ACC-SR-ASM-0046	Si	200-1100 nm	Ø11.28	Room temperature
ACC-SR-ASM-0047	PMT (R928)	185-900 nm	8 x 24	Room temperature
ACC-SR-ASM-0048	PMT (R1527P)	185-680 nm	8 x 24	Room temperature

\* Including gold-focusing mirror for maximum signal collection

Part reference	Function	Features
ACC-SR-ASZ-0053	HV power supply for PMT	0 to 1.5 kV software-controlled range for PMT gain adjustment
ACC-SR-ASZ-0054	Photon counting unit for PMT	Software-selectable discrimination thresholds
ACC-SR-ASZ-0055	Data acquisition unit	USB 2.0 interface, includes 2x SPD acquisition channels, 2x analog outputs for PMT HV power supply control and connections to lock-in amplifiers **

\*\* Recommended models include SRS SR830 with associated SR540 chopper



# Andor in action...

With over 50,000 users worldwide Andor products are represented in all the major universities, helping researchers to achieve key advances and discoveries by offering cutting-edge spectroscopy systems based on the latest technologies available. The result is a great breadth of exciting applications, collaborations and testimonials across researchers' publications, which Andor is extremely proud to share with the scientific community.

Visit the Learning Center now to discover more at [andor.com/learning](http://andor.com/learning).

Innovative techniques and cutting edge research:

- TERS – Label-free chemical analysis of nanostructures in biofilms
- Stand-off LIBS: a detection technique for explosive residues
- Development of a Raman detector for hyphenation with high-temperature liquid chromatography and isotope ratio mass spectrometry
- Magneto-PL unveils photoluminescence in Si nanocrystals
- Novel enabling detector technology

## Have you found what you are looking for?

Can't see your publications referenced when your work involved Andor equipment? Are you interested to put forward some of your key innovations and results? Do you have spectacular images, movies or posters you would be keen to share and are interested in collaboration work around a particular application? Our team of application specialists will be eager to discuss your ideas.







## Customer Support

Andor products are regularly used in critical applications and we can provide a variety of customer support services to maximise the return on your investment and ensure that your product continues to operate at its optimum performance.

Andor has customer support teams located across North America, Asia and Europe, allowing us to provide local technical assistance and advice. Requests for support can be made at any time by contacting our technical support team at [andor.com/support](http://andor.com/support).

Andor offers a variety of support under the following format:

- On-site product specialists can assist you with the installation and commissioning of your chosen product
- Training services can be provided on-site or remotely via the Internet
- A testing service to confirm the integrity and optimize the performance of existing equipment in the field is also available on request.

A range of extended warranty packages are available for Andor products giving you the flexibility to choose one appropriate for your needs. These warranties allow you to obtain additional levels of service and include both on-site and remote support options, and may be purchased on a multi-year basis allowing users to fix their support costs over the operating life cycle of the products.



µManager

### Head Office

7 Millennium Way  
Springvale Business Park  
Belfast BT12 7AL  
Northern Ireland  
Tel: +44 (0)28 9023 7126  
Fax: +44 (0)28 9031 0792

### North America

300 Baker Avenue  
Suite 150  
Concord, MA 01742  
USA  
Tel: +1 860-290-9211  
Fax: +1 860-290-9566

### Japan

5F IS Building  
3-32-42 Higashi-Shinagawa  
Tokyo 140-0002  
Japan  
Tel: +81-(0)3-6732-8968  
Fax: +81-(0)3-6732-8939

### China

Unit 1, Building A,  
No. 66 Zhufang Road,  
Haidian District,  
Beijing 100085  
P. R. China  
Tel: +86 (0)10-8271-9066  
Fax: +86 (0)10-8271-9055

### Find us on

